

Prices shown are not the final selling price.
To obtain the list price, multiply the price by 3.0.
Prices effective as June 2024.

ESSENS OCCASIONAL

design - Jonathan Prestwich



NEW



Rotomolded polyethylene colours

PE1 colours

standard colours

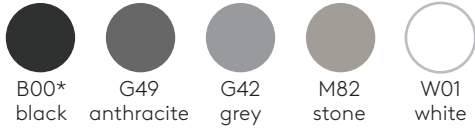

*B00 black 100% recycled material

PE2 colours

composed colours



PE3 colours

standard painted colours



*100% recycled material

PE4 colours

metallic painted colours



PE5 colours

bespoke painted colours

OPTIONALLY, the bases can be painted in all the colours of the RAL sample card, both in gloss and matt finish.

Tabletops

Lacquered MDF

22mm

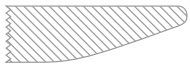

W1 colours



W2 colours

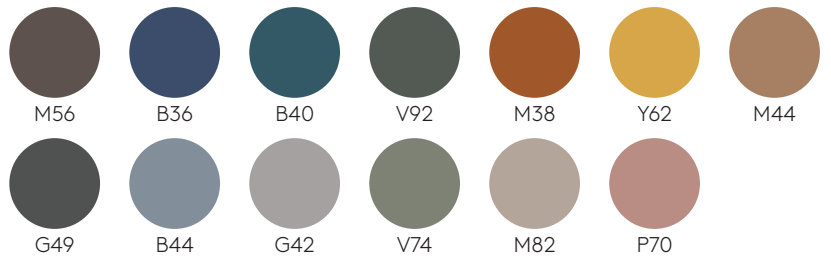

Oak & walnut veneer

23mm

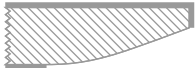

Oak



Walnut

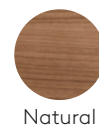

Solid FENIX®

12mm



Solid HPL

12mm white core



Solid HPL

12mm sand core



Solid HPL STONES

12mm

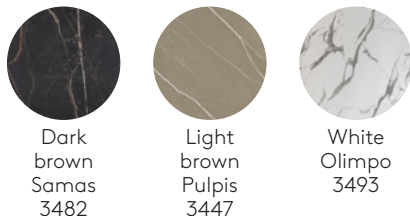

ESSENS OCCASIONAL

NEW

CONFIGURATION GUIDE

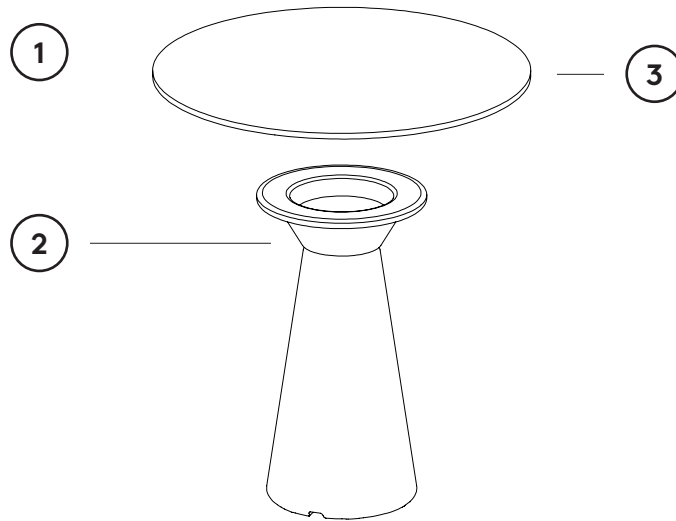

1 **SELECT THE BASE MODEL SUITABLE FOR YOUR TABLE**
The ESSENS collection offers bases in different sizes and formats. Choose the appropriate base for the size of the tabletop you need as indicated bellow next to each base.



TABLETOPS SIZES:

Round tabletops: Ø80cm, Ø90cm and Ø100cm.

Oval tabletops: 110x70cm.



TABLETOPS SIZES:

Round tabletops: Ø40cm and Ø50cm.



TABLETOPS SIZES:

Round tabletops: Ø40cm and Ø50cm.

2 **CHOOSE THE FINISH OF THE BASE**
The bases are available in the following finishes:

Colours PE1	Colours PE2	Colours PE3	Colours PE4	Colours PE5
-------------	-------------	-------------	-------------	-------------

The price matrix shows the price according to the different finishes.

3 **CHOOSE THE TABLETOP MATERIAL AND ITS FINISH**
The tabletops are available in the following materials:

Oak natural/stained	Walnut natural	Lacquered MDF colours W1	Lacquered MDF colours W2	Solid HPL 12mm* white / white core sand / sand core	Solid FENIX® 12mm*	Solid HPL STONES 12mm*
------------------------	-------------------	-----------------------------	-----------------------------	---	-----------------------	------------------------------

The price matrix shows the price according to the different sizes, materials and finishes.

+ **OPTIONAL ITEMS & ACCESSORIES**
ESSENS tables can be ordered with different cable management and electrification accessories. If you need any, please indicate it in the order.

ESSENS OCCASIONAL

NEW

Round base for coffe tables with height 40cm (top not included)

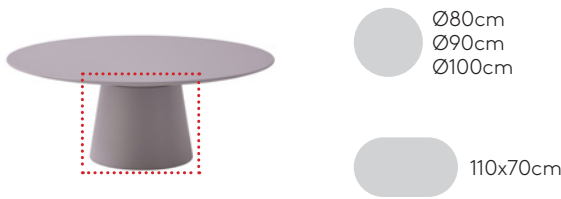

Round polyethylene base Ø45cm for coffe tables with height 40cm. This base allows to build tables with round tops of up to Ø100cm and oval tops of 110x70cm. The inner counterweight is included.

Finishes: in colours PE1, PE2, PE3, PE4 and PE5 from our rothomolded polyethylene swatch card.

[Finishes book +info](#)

Code	Colours PE1 standard	Colours PE2 composed	Colours PE3 standard painted	Colours PE4 metallic painted	Colours PE5 special RAL colours
ES10110BA	261	276	459	469	561

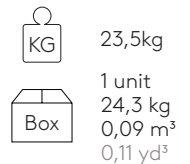
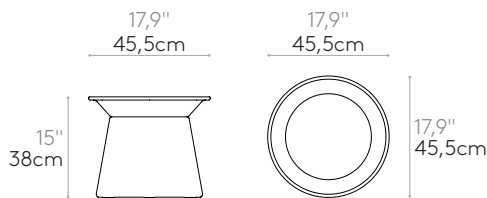

ESSENS OCCASIONAL

NEW

Round tabletops (for round base Ø45cm)

Oval tabletop (for round base Ø45cm)



[Finishes book +info](#)

Top size		80cm	90cm	100cm	110x70cm
Top material	Code	ES20080TP	ES20090TP	ES20100TP	ES21107TP
Oak natural/stained		259	307	376	323
Walnut natural		311	370	439	338
Lacquered MDF colours W1		215	259	324	321
Lacquered MDF colours W2		237	285	356	353
Solid HPL 12mm* white / white core sand / sand core		534	622	784	627
Solid FENIX® 12mm*		570	665	838	491
Solid HPL STONES 12mm*		621	699	842	665

* The size of the HPL tops may have variations of ±1cm.

ESSENS OCCASIONAL

NEW

Round base for side tables with height 44cm (top not included)



Round polyethylene base Ø22cm for side tables with height 44cm. This base allows to build tables with round tops of up to Ø50cm. The inner counterweight is included.

Finishes: in colours PE1, PE2, PE3, PE4 and PE5 from our rothomolded polyethylene swatch card.

[Finishes book ±info](#)

Code	Colours PE1 standard	Colours PE2 composed	Colours PE3 standard painted	Colours PE4 metallic painted	Colours PE5 special RAL colours
ES10120BA	222	237	364	374	522

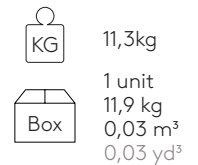
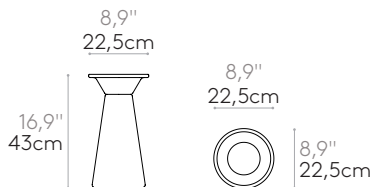

Round base for side tables with height 52cm (top not included)

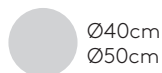

Round polyethylene base Ø22cm for side tables with height 52cm. This base allows to build tables with round tops of up to Ø50cm. The inner counterweight is included.

Finishes: in colours PE1, PE2, PE3, PE4 and PE5 from our rothomolded polyethylene swatch card.

[Finishes book ±info](#)

Code	Colours PE1 standard	Colours PE2 composed	Colours PE3 standard painted	Colours PE4 metallic painted	Colours PE5 special RAL colours
ES10130BA	232	247	398	408	532

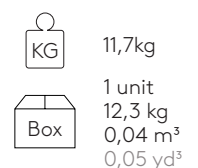
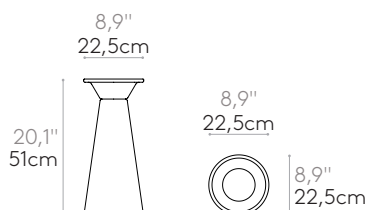

Prices shown are not the final selling price.
To obtain the list price, multiply the price by 3.0.
Prices effective as June 2024.

ESSENS OCCASIONAL

NEW

Round tabletops (for round base Ø22cm)







Finishes book [±info](#)

Top size		40cm	50cm
Top material	Code	ES20040TP	ES20050TP
Oak natural/stained		154	176
Walnut natural/stained		159	183
Lacquered MDF colours W1		126	149
Lacquered MDF colours W2		139	164
Solid HPL 12mm* white / white core sand / sand core		189	254
Solid FENIX® 12mm*		165	215
Solid HPL STONES 12mm*		197	266

* The size of the HPL tops may have variations of ±1cm.

OPTIONAL ITEMS & ACCESSORIES

	Code	Description	€
	ELC0030EL	Wireless induction charger Ø80mm (Output: 2m cable Micro USB to USB) *A drawing of the top with the exact position of cut-outs must be attached to the order.	217
	ELC0040EL	USB charger with 2 ports Ø30mm (Output: 1,5m cable + Schucko transformer) *A drawing of the top with the exact position of cut-outs must be attached to the order.	125
	ELC0050EL	On top Schuko socket Ø56mm (Output: 20cm cable + WIELAND connection) *A drawing of the top with the exact position of cut-outs must be attached to the order	103
	ELC0090EL	On top Schuko socket + USB-A + USB-C Ø60mm (Output: 20cm cable + WIELAND connection) *A drawing of the top with the exact position of cut-outs must be attached to the order	276