



Designed by Jonathan Prestwich, the ESSENS tables combine versatility, beauty and harmonious proportions. The meeting point between two essential volumes in equilibrium generates a table base with a sculptural outline. The highly transversal ESSENS programme of tables comprises six types of 100% recyclable polyethylene table bases that allow composing tables in an endless variety of formats and sizes. The original design makes possible to configure tables with a single top or tables by sections of endless size. The bases have been designed to easily solve cable management. The tables can be equipped with different sockets, chargers, connections and accessories. The multiple possibilities of base and top combinations, together with the extensive range of available finishes, allows for endless customisation possibilities.

---

## FINISHES

### Rotomolded polyethylene colours

#### PE1 colours

standard colours

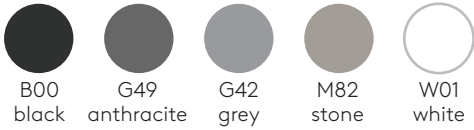

B00 black G49 anthracite G42 grey M82 stone W01 white

#### PE2 colours

composed colours

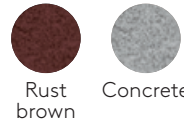

Rust brown Concrete

#### PE3 colours

standard painted colours

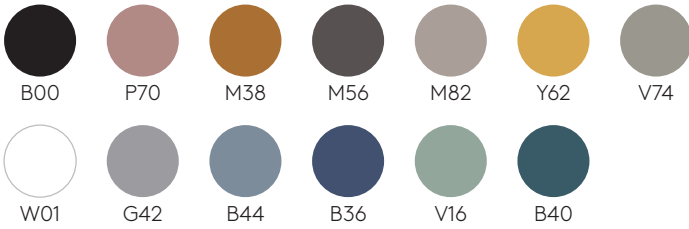

B00 P70 M38 M56 M82 Y62 V74  
W01 G42 B44 B36 V16 B40

#### PE4 colours

metallic painted colours



Silver Gold Copper

#### PE5 colours

bespoke painted colours

OPTIONALLY, the bases can be painted in all the colours of the RAL sample card, both in gloss and matt finish.

### Tabletops

#### Lacquered MDF

22mm

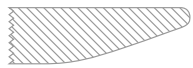

#### W1 colours



W01 B00

#### W2 colours

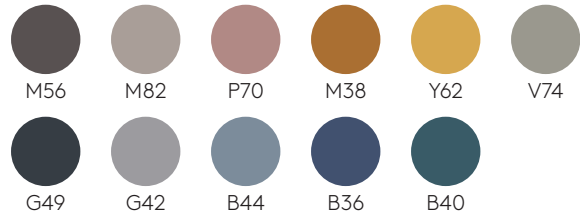

M56 M82 P70 M38 Y62 V74  
G49 G42 B44 B36 B40

#### Oak & walnut veneer

23mm

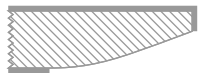

#### Oak



Natural Walnut stain Wenge stain Black stain

#### Walnut



Natural

#### Solid HPL

12mm black core



White Black

#### Solid HPL

12mm white core



White

#### Solid FENIX®

12mm



Black

#### Natural marbles

20mm

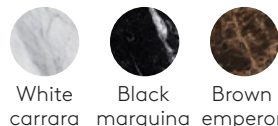

White carrara Black marquina Brown emperor

## CONFIGURATION GUIDE - TABLES WITH ROUND OR ELLIPTICAL BASES

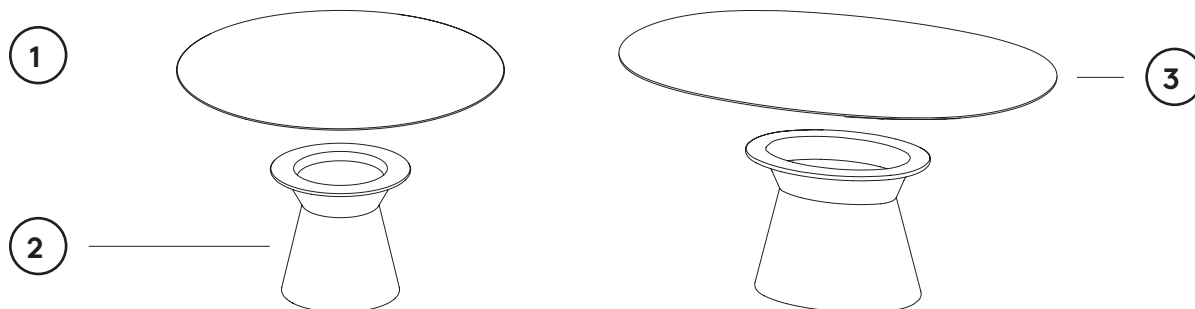

**1** **SELECT THE BASE MODEL SUITABLE FOR YOUR TABLE**  
 The ESSENS collection offers bases in different sizes and formats. Choose the appropriate base for the size of the tabletop you need as indicated below next to each base.  
**Remark:** the bases must be filled with the counterweight indicated for each one so that the table is stable. If you want to buy the counterweight from INCLASS, you must indicate in the order the code that appears in the price matrix of each base.

 Ø38cm H75	<p><b>TABLETOPS SIZES:</b></p> <p>Round tabletops: Ø60cm, Ø70cm, Ø80cm, Ø90cm and Ø100cm.</p> <p>Square tabletops: 60x60cm, 70x70cm, 80x80cm and 90x90cm.</p>
 Ø38cm H105	<p><b>TABLETOPS SIZES:</b></p> <p>Round tabletops: Ø60cm, Ø70cm, Ø80cm and Ø90cm.</p> <p>Square tabletops: 60x60cm, 70x70cm and 80x80cm.</p>
 Ø50cm H75	<p><b>TABLETOPS SIZES:</b></p> <p>Round tabletops: Ø120cm and Ø140cm.</p> <p>Square tabletops: 100x100cm and 120x120cm.</p>
 Ø65cm H75	<p><b>TABLETOPS SIZES:</b></p> <p>Round tabletops: Ø160cm, Ø180cm and Ø200cm.</p> <p>Square tabletops: 140x140cm and 160x160cm.</p>
 Elliptical base 95x63cm H75	<p><b>TABLETOP SIZE:</b></p> <p>Elliptical tabletops: 220x140cm, 240x140cm, 260x150cm and 280x150cm.</p>

**2** **CHOOSE THE FINISH OF THE BASE**  
 The bases are available in the following finishes:

Colours PE1	Colours PE2	Colours PE3	Colours PE4	Colours PE5
-------------	-------------	-------------	-------------	-------------

The price matrix shows the price according to the different finishes.

**3** **CHOOSE THE TABLETOP MATERIAL AND ITS FINISH**  
 The tabletops are available in the following materials:

Oak natural/stained	Walnut natural	Lacquered MDF colours W1	Lacquered MDF colours W2	Solid HPL 12mm*	Solid FENIX® 12mm*	Marble white	Marble black / brown
------------------------	-------------------	-----------------------------	-----------------------------	--------------------	-----------------------	-----------------	-------------------------

The price matrix shows the price according to the different sizes, materials and finishes.

**+** **OPTIONAL ITEMS & ACCESSORIES (page 249)**  
 ESSENS tables can be ordered with different cable management and electrification accessories. If you need any, please indicate it in the order.

## CONFIGURATION GUIDE - TABLES WITH OVAL BASES

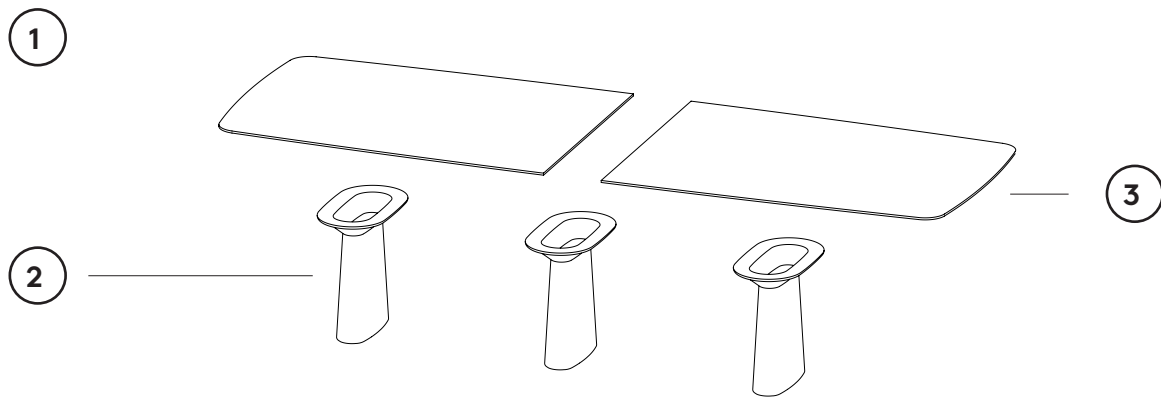

### 1 SELECT THE TABLE DIMENSIONS

The table with oval bases can be assembled with one piece tops or tops by sections.



#### TABLES WITH ONE PIECE TOP

Standard sizes: 200x100cm, 220x120cm, 240x120cm, 260x120cm, 280x140cm, and 300x140cm. Two oval bases are needed for these tables.



#### TABLES WITH TWO END TOPS

Standard sizes: 400x140cm, 500x140cm and 600x140cm. Three oval bases are needed for these tables.



#### TABLES WITH MULTIPLE TOP SECTIONS

They are configured with two end tabletops, available in sizes 250x140cm and 300x140cm and the desired intermediate tabletops by sections of 200x140cm. An oval base is required for each end tabletop and for each joint of the intermediate sections.

Examples:

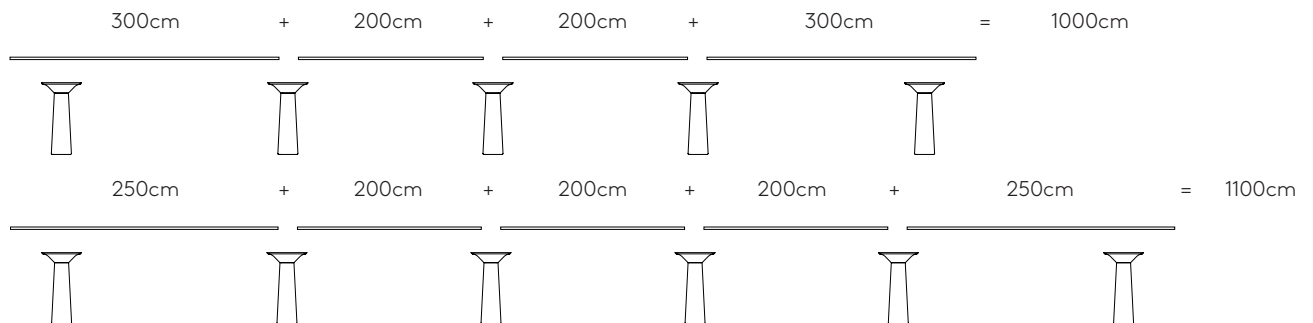

#### Remark:

- The oval base cannot be used as a single base, regardless of the measurements of the tabletop.
- The tabletops bigger than 260x120cm include reinforcement steel beams beneath the top.
- The bases must be filled with the counterweight indicated for each base so that the table is stable. If you want to buy it from INCLASS, you must indicate in the order the code that appears in the price matrix of each base.

### 2 CHOOSE THE FINISH OF THE BASE

The bases are available in the following finishes:

Colours PE1	Colours PE2	Colours PE3	Colours PE4	Colours PE5
-------------	-------------	-------------	-------------	-------------

The price matrix shows the price according to the different finishes.

### 3 CHOOSE THE TABLETOP MATERIAL AND ITS FINISH

The tabletops are available in the following materials:

Oak natural/stained	Walnut natural	Lacquered MDF colours W1	Lacquered MDF colours W2	Solid HPL 12mm*	Solid FENIX® 12mm*
------------------------	-------------------	-----------------------------	-----------------------------	--------------------	-----------------------

The price matrix shows the price according to the different sizes, materials and finishes.

### + OPTIONAL ITEMS & ACCESSORIES (page 249)

ESSENS tables can be ordered with different cable management and electrification accessories. If you need any, please indicate it in the order.

## Round base 38cm (top not included)

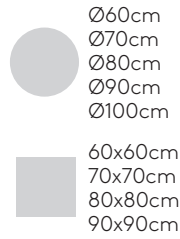

Round polyethylene table base Ø38cm. This base allows to build tables with round tops of up to Ø100cm and square tops of up to 90x90cm. The inner counterweight must be acquired separately.

For this base we recommend a minimum inner counter weight of 25kg.

**Finishes:** in colours PE1, PE2, PE3, PE4 and PE5 from the rothomolded polyethylene swatch card.

[Finishes book ±info](#)

Code	Colours PE1 standard	Colours PE2 composed	Colours PE3 standard painted	Colours PE4 metallic painted	Colours PE5 special RAL colours
ES10010BA	260	274	512	534	588

Code	Optional items & accessories	€
ES30010OP	Counterweight 25kg of gravel	+20€
ES30020PS	Cable management tube for base	+78€

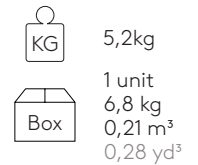
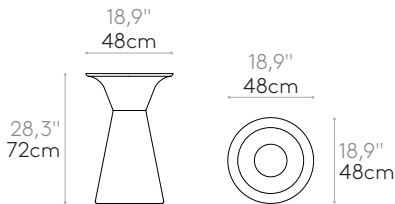

## Round base 38cm stool height (top not included)

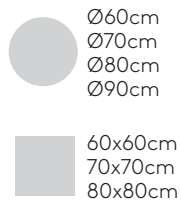

Round high polyethylene table base Ø38cm. This base allows to build tables with round tops of up to Ø90cm and square tops of up to 80x80cm. The inner counterweight must be acquired separately.

For this base we recommend a minimum inner counter weight of 25 kg.

**Finishes:** in colours PE1, PE2, PE3, PE4 and PE5 from the rothomolded polyethylene swatch card.

[Finishes book ±info](#)

Code	Colours PE1 standard	Colours PE2 composed	Colours PE3 standard painted	Colours PE4 metallic painted	Colours PE5 special RAL colours
ES10040BA	321	338	636	664	730

Code	Optional items & accessories	€
ES30010OP	Counterweight 25kg of gravel	+20€
ES30024PS	Cable management tube for base	+83€

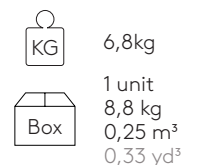
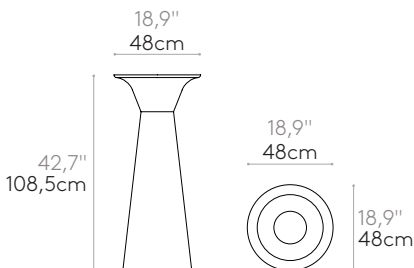

## Round tabletops (for round base 38cm)



Tabletops for tables with round bases 38cm.  
The prices indicated below are only for the tabletops.

Top size		60cm	70cm	80cm	90cm	100cm
Top material	Code	ES20060TP	ES20070TP	ES20080TP	ES20090TP	ES20100TP
<b>Oak</b> natural/stained		183	213	249	295	362
<b>Walnut</b> natural/stained		219	254	299	356	422
<b>Lacquered MDF</b> colours W1		146	171	207	249	312
<b>Lacquered MDF</b> colours W2		161	188	228	274	343
<b>Solid HPL</b> 12mm* black core		192	224	258	296	349
<b>Solid HPL</b> 12mm* white core		381	452	513	598	754
<b>Solid FENIX®</b> 12mm*		407	483	548	639	806
<b>Marble</b> white		914	1.029	1.158	1.258	1.543
<b>Marble</b> black/brown		838	934	1.020	1.120	1.356

## Square tabletops (for round base 38cm)



Tabletops for tables with round bases 38cm.  
The prices indicated below are only for the tabletops.

Top size		60x60cm	70x70cm	80x80cm	90x90cm
Top material	Code	ES20606TP	ES20707TP	ES20808TP	ES20909TP
<b>Oak</b> natural/stained		210	246	296	342
<b>Walnut</b> natural/stained		245	287	347	402
<b>Lacquered MDF</b> colours W1		187	195	258	293
<b>Lacquered MDF</b> colours W2		206	215	284	322
<b>Solid HPL</b> 12mm* black core		194	228	263	301
<b>Solid HPL</b> 12mm* white core		383	459	516	602
<b>Solid FENIX®</b> 12mm*		409	491	551	643

\* The size of the HPL tops may have variations of ±1cm.

All prices listed in €. Taxes not included

[GO TO INDEX](#) ↗

# ESSENS

## Round base 50cm (top not included)



Ø120cm  
Ø140cm

100x100cm  
120x120cm

Round polyethylene table base Ø50cm. This base allows to build tables with round tops of up to Ø140cm and square tops of up to 120x120cm. The inner counterweight must be acquired separately.

For this base we recommend a minimum inner counter weight of 50kg.

**Finishes:** in colours PE1, PE2, PE3, PE4 and PE5 from the rothomolded polyethylene swatch card.

Code	Colours PE1 standard	Colours PE2 composed	Colours PE3 standard painted	Colours PE4 metallic painted	Colours PE5 special RAL colours
ES10020BA	340	356	643	674	741

Code	Optional items & accessories	€
ES30014OP	Counterweight 50kg of gravel	+42€
ES30022PS	Cable management tube for base	+78€

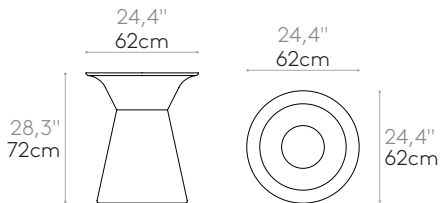

KG 10,4kg  
1 unit  
12 kg  
Box 0,21 m<sup>3</sup>  
0,28 yd<sup>3</sup>

## Round tabletops (for round base 50cm)



	Top size	120cm	140cm
<b>Top material</b>	Code	ES20120TP	ES20140TP
<b>Oak</b> natural/stained		496	653
<b>Walnut</b> natural/stained		560	738
<b>Lacquered MDF</b> colours W1		435	594
<b>Lacquered MDF</b> colours W2		479	653
<b>Solid HPL</b> 12mm* black core		533	619
<b>Solid HPL</b> 12mm* white core		914	1.281
<b>Solid FENIX®</b> 12mm*		976	1.368
<b>Marble</b> white		1.950	2.363
<b>Marble</b> black/brown		1.648	1.923

## Square tabletops (for round base 50cm)



	100x100cm	120x120cm	
<b>Top material</b>	Code	ES21010TP	ES21212TP
		433	572
		471	609
		382	518
		420	570
		343	547
		758	910
		810	972
		—	—
		—	—

# ESSENS

## Round base 65cm (top not included)



 Ø160cm  
 Ø180cm  
 Ø200cm

 140x140cm  
 160x160cm

Round polyethylene table base Ø65cm. This base allows to build tables with round tops of up to Ø200cm and square tops of up to 160x160cm. The inner counterweight must be acquired separately.

For this base we recommend a minimum inner counter weight of 75kg.

**Finishes:** in colours PE1, PE2, PE3, PE4 and PE5 from the rothomolded polyethylene swatch card.

Code	Colours PE1 standard	Colours PE2 composed	Colours PE3 standard painted	Colours PE4 metallic painted	Colours PE5 special RAL colours
ES10050BA	562	584	945	980	1.097

Code	Optional items & accessories	€
ES30016OP	Counterweight 75kg of gravel	+62€
ES30023PS	Cable management tube for base	+78€

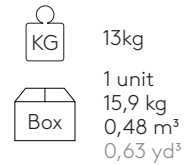
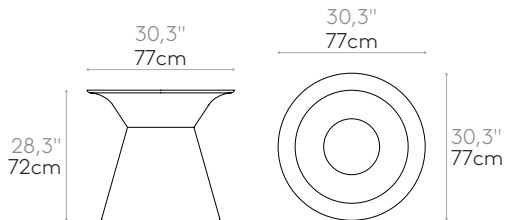

## Round tabletops (for round base 65cm)



	Top size	160cm	180cm	200cm
Top material	Code	ES20160TP	ES20180TP	ES20200TP
<b>Oak</b> natural/stained		1.004	1.329	1.842
<b>Walnut</b> natural/stained		1.426	1.453	2.010
<b>Lacquered MDF</b> colours W1		731	967	1.512
<b>Lacquered MDF</b> colours W2		804	1.064	1.663
<b>Solid HPL</b> 12mm* black core		934	—	—
<b>Solid HPL</b> 12mm* white core		—	—	—
<b>Solid FENIX®</b> 12mm*		1.645	—	—
<b>Marble</b> white		2.892	—	—
<b>Marble</b> black/brown		2.292	—	—

## Square tabletops (for round base 65cm)



	140x140cm	160x160cm
	ES21414TP	ES21616TP
	759	1.133
	808	1.199
	670	870
	737	957
	640	905
	1.276	1.511
	1.363	1.614
	—	—
	—	—



# ESSENS

## Elliptical base (top not included)



220x140cm  
240x140cm  
260x150cm  
280x150cm

Elliptical polyethylene table base. This base allows to build tables with elliptical tops of up to 280x150cm. The inner counterweight must be acquired separately.

For this base we recommend a minimum inner counter weight of 125kg.

**Finishes:** in colours PE1, PE2, PE3, PE4 and PE5 from the rothomolded polyethylene swatch card.

Code	Colours PE1 standard	Colours PE2 composed	Colours PE3 standard painted	Colours PE4 metallic painted	Colours PE5 special RAL colours
ES10060BA	641	679	1.154	1.196	1.340

Code	Optional items & accessories	€
ES30018OP	Counterweight 125kg of gravel	+105€
ES30027PS	Cable management tube for base	+78€

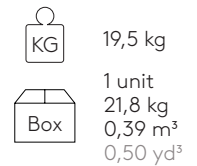
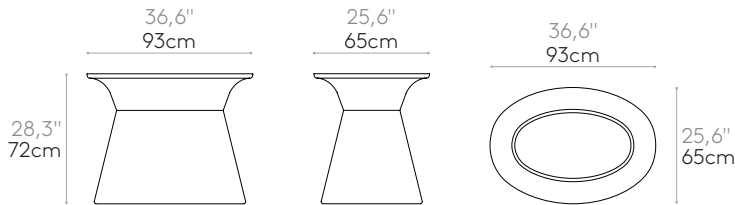

## Elliptical tabletops (for elliptical bases)



Tabletops for tables with elliptical bases.

The prices indicated below are only for the tabletops.

	Top size	220x140cm	240x140cm**	260x150cm**	280x150cm**
<b>Top material</b>	Code	ES22214TE	ES22414TE	ES22615TE	ES22815TE
<b>Oak</b> natural/stained		1.521	1.970	2.192	2.378
<b>Walnut</b> natural/stained		1.753	2.182	2.450	2.581
<b>Lacquered MDF</b> colours W1		1.317	1.747	2.043	2.183
<b>Lacquered MDF</b> colours W2		1.449	1.922	2.247	2.401
<b>Solid HPL</b> 12mm* black core		1.233	1.692	1.908	2.036
<b>Solid HPL</b> 12mm* white core		2.243	2.757	—	—
<b>Solid FENIX®</b> 12mm*		2.397	2.946	3.398	3.640
<b>Marble**</b> white		4.964	5.090	—	—
<b>Marble**</b> black/brown		4.805	4.979	—	—

# ESSENS

## Oval base (top not included)



Oval polyethylene table base. Using multiple bases allows to build tables with a maximum width of 140cm and infinite length. The inner counterweight must be acquired separately.

For this base we recommend a minimum inner counter weight of 40kg.

**Finishes:** in colours PE1, PE2, PE3, PE4 and PE5 from the rothomolded polyethylene swatch card.

Code	Colours PE1 standard	Colours PE2 composed	Colours PE3 standard painted	Colours PE4 metallic painted	Colours PE5 special RAL colours
ES10030BA	315	331	610	644	708

Code	Optional items & accessories	€
ES30012OP	Counterweight 40kg of gravel	+34€
ES30026PS	Cable management tube for base	+78€



2 bases

**With 2 bases:** 200x100, 220x120, 240x120, 260x120, 280x140x 300x140cm



3 bases

**With 3 bases:** 400x140, 500x140, 600x140cm



4 bases

**With 4 bases:** 700x140, 800x140cm

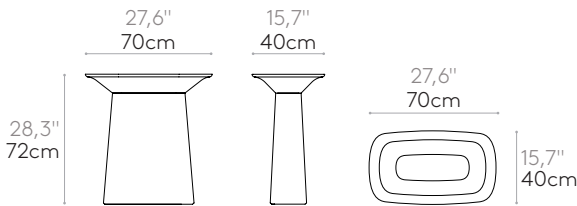

6,1kg



1 unit  
7,8 kg  
0,21 m<sup>3</sup>  
0,28 yd<sup>3</sup>

## Oval tabletops (for tables with 2 bases)



Tabletops for tables with 2 oval bases.

The prices indicated below are only for the tabletops.

Top size	200x100cm	220x120cm	240x120cm	260x120cm**	280x140cm**	300x140cm**	
Top material	Code	ES22010TP	ES22212TP	ES22412TP	ES22612TP	ES22814TP	ES23014TP
<b>Oak</b> natural/stained		1.116	1.352	1.466	1.868	2.183	2.261
<b>Walnut</b> natural/stained		1.247	1.513	1.642	2.139	2.429	2.613
<b>Lacquered MDF</b> colours W1		884	1.080	1.159	1.511	1.975	1.970
<b>Lacquered MDF</b> colours W2		972	1.188	1.275	1.662	2.173	2.167
<b>Solid HPL</b> 12mm* black core		898	1.170	1.274	1.648	1.928	1.963
<b>Solid HPL</b> 12mm* white core		1.628	1.813	2.096	2.571	3.099	3.482
<b>Solid FENIX®</b> 12mm*		1.739	1.937	2.240	2.746	3.310	3.721

## Oval tabletops (for tables with 3 bases)



## (for tables with 4 bases)









Top size	400x140cm**	500x140cm**	600x140cm**	700x140cm**	800x140cm**	
Top material	Code	ES24014TP	ES25014TP	ES26014TP	ES27014TP	ES28014TP
<b>Oak</b> natural/stained		3.284	4.037	4.716	5.697	6.330
<b>Walnut</b> natural/stained		3.493	4.303	4.964	6.078	6.749
<b>Lacquered MDF</b> colours W1		2.910	3.612	4.203	4.929	5.456
<b>Lacquered MDF</b> colours W2		3.201	3.973	4.623	5.422	6.002
<b>Solid HPL</b> 12mm* black core		2.726	3.410	4.040	4.694	5.281
<b>Solid HPL</b> 12mm* white core		4.551	5.691	6.928	7.893	9.136
<b>Solid FENIX®</b> 12mm*		4.862	6.080	7.402	8.432	9.760

\* The size of the HPL tops may have variations of ±1cm.

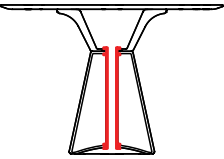

\*\* Includes reinforcement steel beams.

All prices listed in €. Taxes not included

## OPTIONAL ITEMS & ACCESSORIES

	Code	Description	€	
	ES30010OP	25kg inner counterweight of gravel for table base	20	
	ES30012OP	40kg inner counterweight of gravel for table base	34	
	ES30014OP	50kg inner counterweight of gravel for table base	42	
	ES30016OP	75kg inner counterweight of gravel for table base	62	
	ES30018OP	125kg inner counterweight of gravel for table base	105	
	ES30020PS	Cable management tube for base 38cm	78	
	ES30022PS	Cable management tube for base 50cm	78	
	ES30023PS	Cable management tube for base 65cm	78	
	ES30024PS	Cable management tube for base 38cm stool height	83	
	ES30026PS	Cable management tube for oval base	78	
	ES30027PS	Cable management tube for elliptical base	78	
		ES41212MA	Cut-out with lid for top access (12x12cm)	134
		ES41224MA	Cut-out with lid for top access (24x12cm)	145
ES41236MA		Cut-out with lid for top access (36x12cm)	149	
ES40120MA		Cut-out with lid for top access (Ø12cm)	133	
	ES40010ME	Custom cut-out on tabletop	102	
	ELC0010	Plastic cable grommet with cover Ø80mm (Available in black or white)	29	
	ELC0020EL	Brushed aluminium grommet with cover Ø80mm	65	
	ELC0060EL	Self adhesive cable holder mesh 30x40cm	36	
	ELC0140	Under top cable tray L.40cm (Size: 140x80x400mm)	58	
	ELC0180	Under top cable tray L.80cm (Size: 140x80x800mm)	84	

## OPTIONAL ITEMS & ACCESSORIES

	Code	Description	€
	ELC0030EL	Wireless induction charger Ø80mm (Output: 2m cable Micro USB to USB)	157
	ELC0040EL	USB charger with 2 ports Ø30mm (Output: 1,5m cable + Schucko transformer)	121