

Hug

Manufacturer: Lebom, Spain

Hug

Francesc Rifé



Structure

- Solid wood and DM board.
- Springs in high resistance elastic belts..

Padding

- 40 g Biogreen polyurethane seat with a 80 kg vicoelastic topper.
- 5 kg super soft polyurethane back and 350 g layer.

Upholstery

- Seams in arms and backs.
- Removable decorative cushions

Standing

Metallic frame.

Hug

Manufacturer: Lebom, Spain

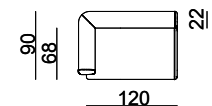
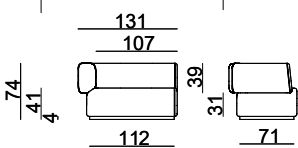
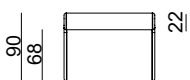
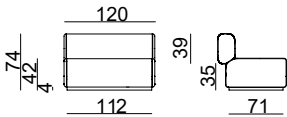
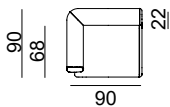
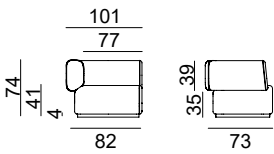
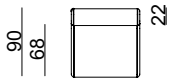
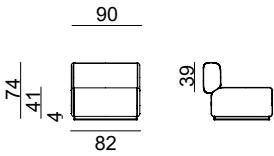
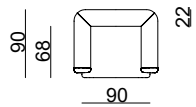
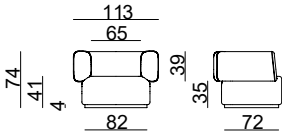

Hug

Fabrics

P0 COM	P1	P2	P3	Vol (ft³)
-----------	----	----	----	-----------

CAD \$

	P0 COM	P1	P2	P3	Vol (ft³)
Armchair 107310	\$4,468	\$5,009	\$5,551	\$6,089	36.49
Module 90 107345	\$3,347	\$3,695	\$4,043	\$4,388	29.66
Module 90 arm R 107342 L 107343	\$3,902	\$4,347	\$4,789	\$5,234	32.93
Module 120 (1 seat) 107321	\$3,923	\$4,268	\$4,616	\$4,965	38.56
Module 120 arm (1 seat) R 107322 L 107323	\$4,475	\$4,920	\$5,361	\$5,806	41.83

Hug

Manufacturer: Lebom, Spain

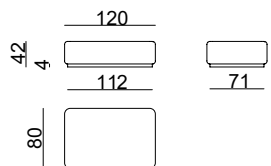
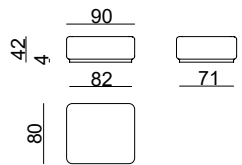
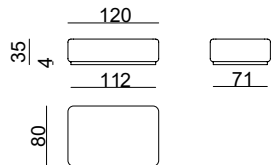
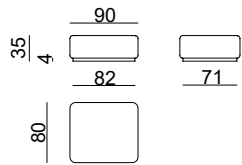
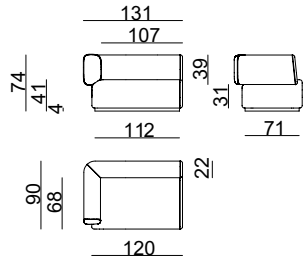

Hug

Fabrics

P0 COM	P1	P2	P3	Vol (ft³)
-----------	----	----	----	-----------

CAD \$

Module 120 corner R 107370 L 107371	\$4,454	\$4,916	\$5,375	\$5,834	41.83
Island 90x80 low 107362	\$2,287	\$2,525	\$2,760	\$2,998	13.98
Island 120x80 low 107363	\$2,512	\$2,774	\$3,033	\$3,291	18.18
Island 90x80 high 107360	\$2,287	\$2,525	\$2,760	\$2,998	16.21
Island 120x80 high 107361	\$2,512	\$2,774	\$3,033	\$3,291	21.07

Hug

Manufacturer: Lebom, Spain

Hug

Fabrics

P0 COM	P1	P2	P3	Vol (ft³)
-----------	----	----	----	-----------

CAD \$

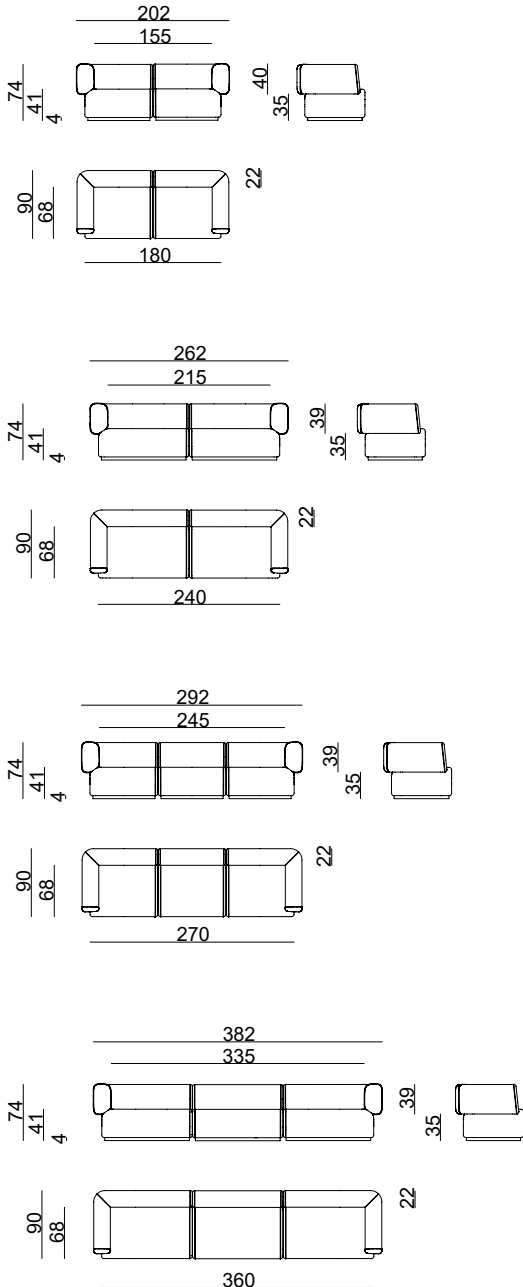

	P0 COM	P1	P2	P3	Vol (ft³)
90 BI + 90 BD	\$7,804	\$8,694	\$9,577	\$10,467	62.89
120 BI + 120 BD	\$8,949	\$9,839	\$10,723	\$11,613	80.69
90 BI + 90 + 90 BD	\$11,150	\$12,389	\$13,621	\$14,856	89.59
120 BI + 120 + 120 BD	\$12,872	\$14,107	\$15,339	\$16,577	116.28

Hug

Manufacturer: Lebom, Spain

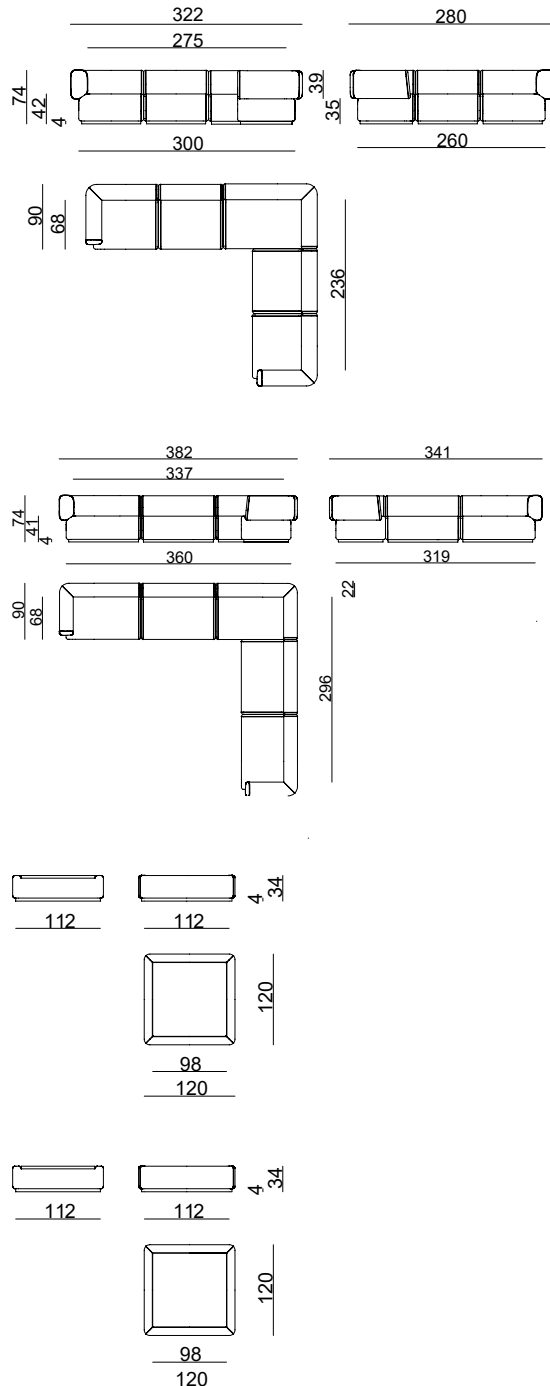

Hug

Fabrics

P0 COM	P1	P2	P3	Vol (ft³)
-----------	----	----	----	-----------

CAD \$

**90 BI + 90 +
CORNER D + 90 +
90 BD**

\$18,951	\$21,000	\$23,039	\$25,078	286.59
----------	----------	----------	----------	--------

**120 BI + 120 +
CORNER D + 120
+ 120 BD**

\$21,249	\$23,291	\$25,330	\$27,376	408.16
----------	----------	----------	----------	--------

**Table 120x120
Marble
107392**

\$5,586	\$5,775	\$5,934	\$6,044	26.26
---------	---------	---------	---------	-------

**Table 120x120
Lacquered
107392**

\$2,798	\$2,988	\$3,146	\$3,257	26.26
---------	---------	---------	---------	-------

COM Orders are subject to following charges per manufacturer: \$18 per yard (any fabric) - Minimum: \$200.



Tusch Seating International Inc.
251 Bartley Dr. Unit #4
Toronto, ON M4A 2N7 Canada
www.tuschseating.com

T 416.368.6100
F 416.368.4477
T 888.368.6101
info@tuschseating.com