

nido  
javier pastor, 2010/2019

[en] *Nido* is a modular upholstered collection, with a structure made of stainless steel tube, thus guaranteeing outdoor use. "I suggest that the structure be dressed in a denser rope braid in order to enrich the textures and finishes of this collection and provide greater warmth."





C250T Nido. Hand-woven low armchair / sillón bajo tejido. 108 FT oxide. 513 SPK oxide speckled. Heritage ash



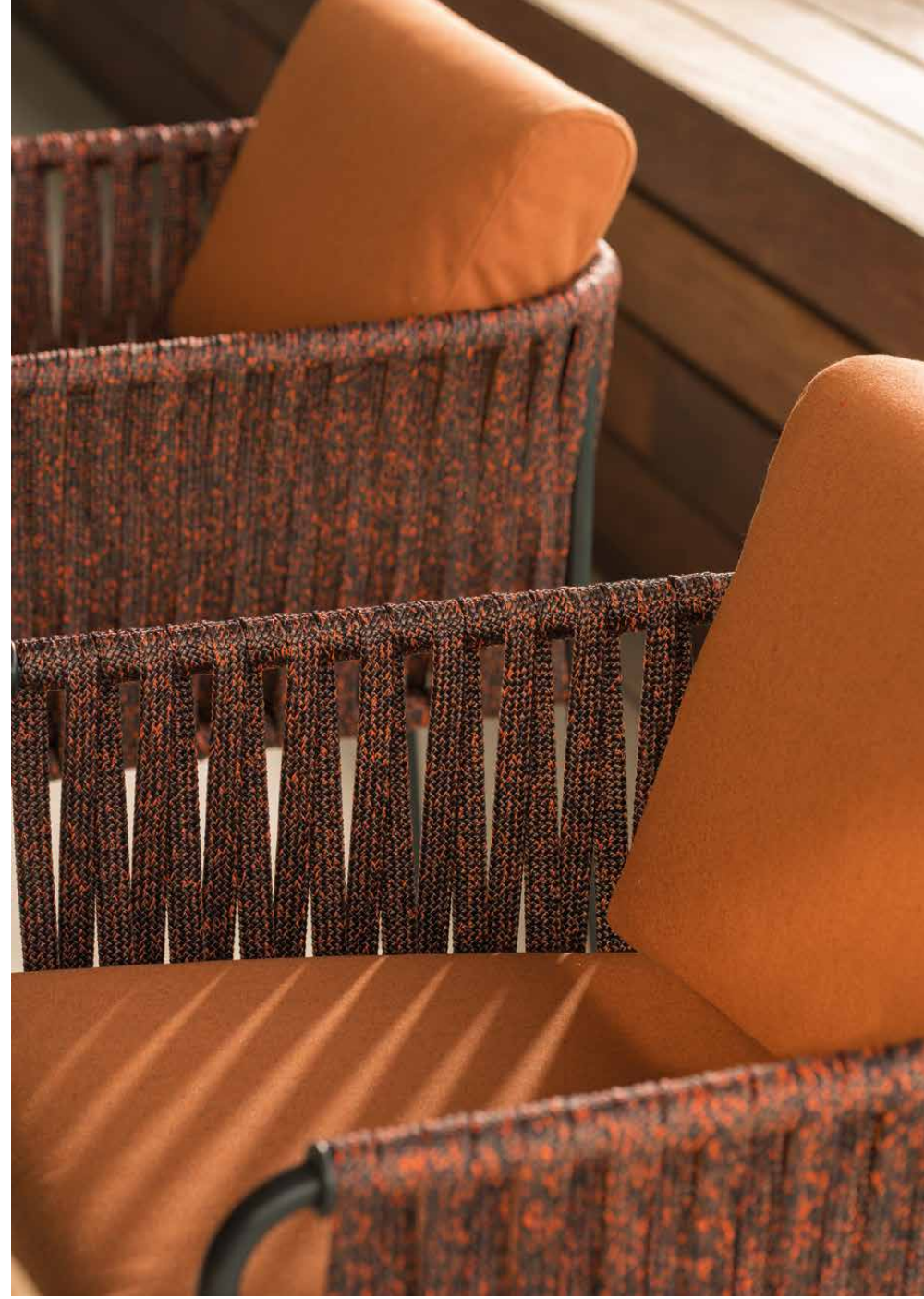

C258T Nido. Hand-woven dining armchair / sillón comedor tejido. 111 FT graphite. 511 SPK dark orange speckled. Heritage pumpkin



C254T Nido. XL hand-woven sofa / sofà tejido XL. 113 FT sage. 520 SPK sand speckled. Natté taupe chalk. Natté taupe chalk - natté frosty chiné

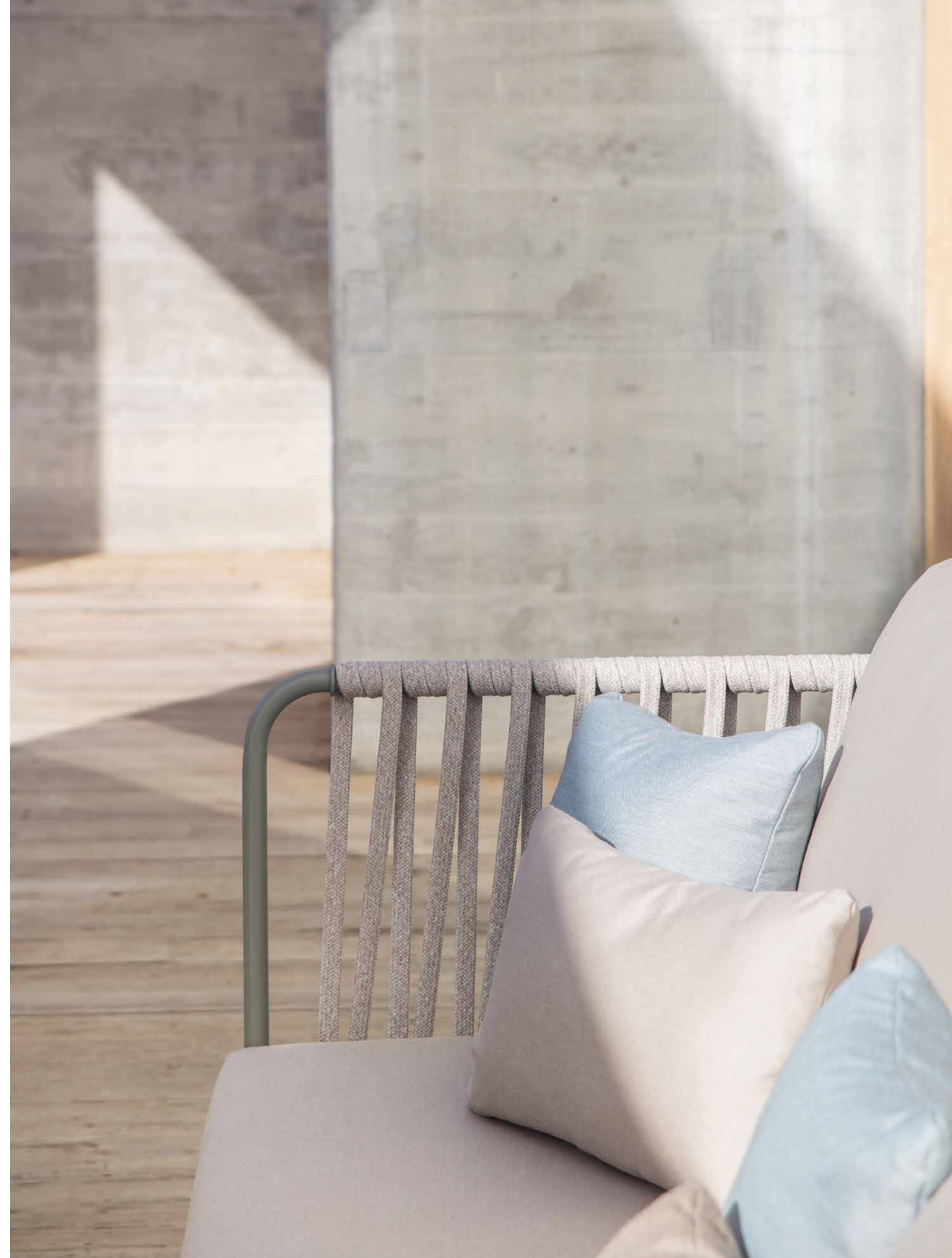

C254T Nido. XL hand-woven sofa / sofá tejido XL. 113 FT sage. 520 SPK sand speckled. Natté taupe chalk. Natté taupe chalk - natté frosty chiné

C272T Nido. Hand-woven central module / módulo central tejido. 108 FT oxide. 513 SPK oxide speckled. Heritage papyrus. Heritage pumpkin. Heritage papyrus  
C271T Nido. Hand-woven right side module / módulo lateral d'cho. tejido. 108 FT oxide. 513 SPK oxide speckled. Heritage papyrus. Heritage pumpkin - Heritage papyrus  
C273T Nido. Hand-woven left chaise longue module / Módulo chaise longue izq. tejido. 108 FT oxide. 513 SPK oxide speckled. Heritage papyrus. Heritage pumpkin

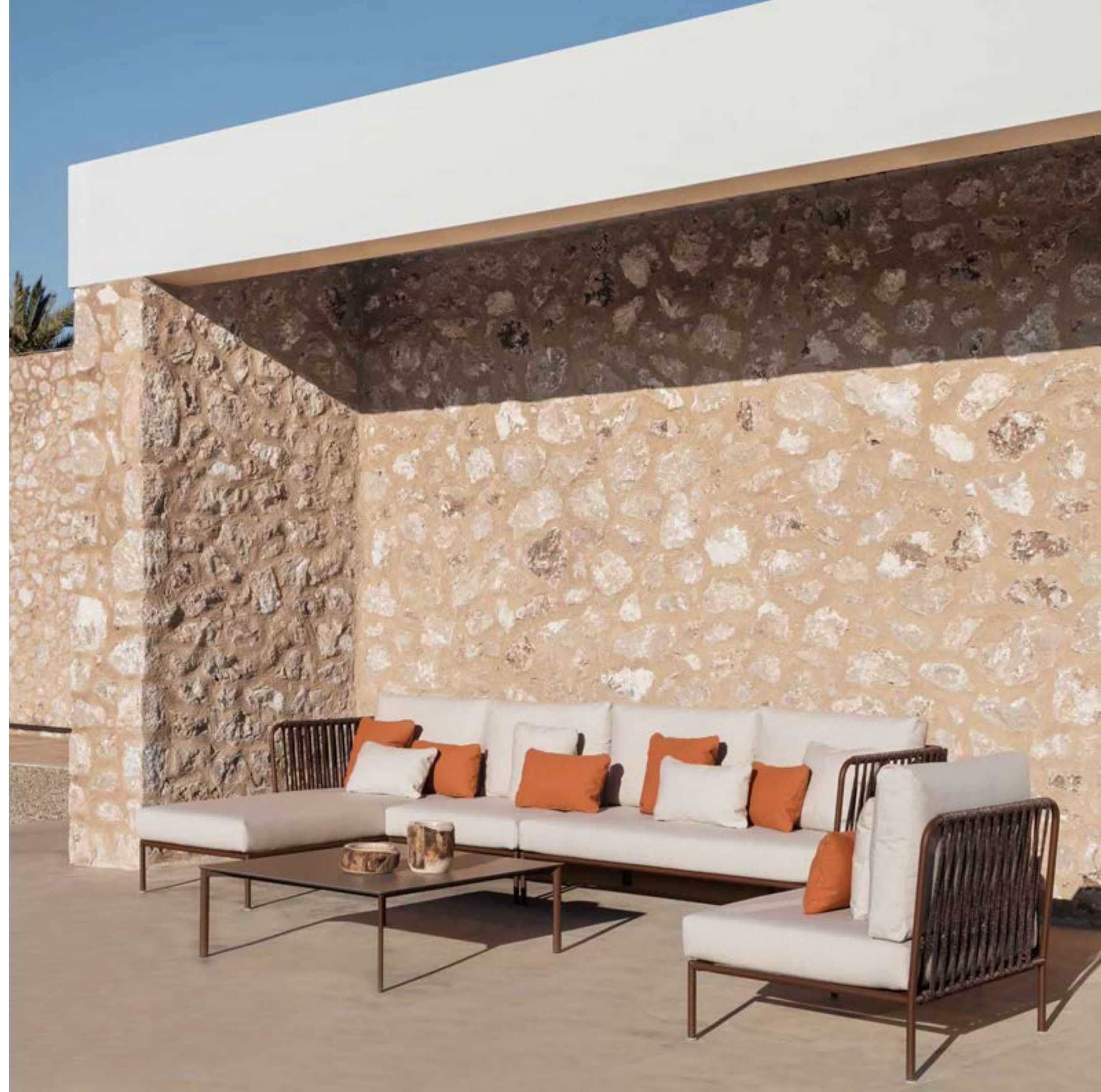

C270T Nido. Hand-woven left side module / módulo lateral izq. tejido. 111 FT graphite. 509 taupe. Customer fabric  
C271T Nido. Hand-woven right side module / módulo lateral dcho. tejido. 111 FT graphite. 509 taupe. Customer fabric  
C273T Nido. Hand-woven left chaise longue module / módulo chaise longue izq. tejido. 111 FT graphite. 509 taupe. Customer fabric







C251T Nido. Hand-woven armchair / sillón tejido. 102 FT light grey. 526 SPK turquoise speckled. Strada 07

C259T Nido. Hand-woven barstool / taburete tejido. 108 FT oxide. 510 SPK orange speckled. Natté canvas



# nido

[en] Collection made of stainless steel tube, and finished with polyester powder. Hand-woven finish with high resistance rope 24 mm/0.94" wide. Possibility of creating a wide variety of layouts thanks to the modularity of its elements.

javier pastor, 2010/2019

**C270 T**  
—  
Hand-woven left side module

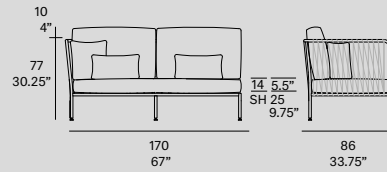

**C271 T**  
—  
Hand-woven right side module

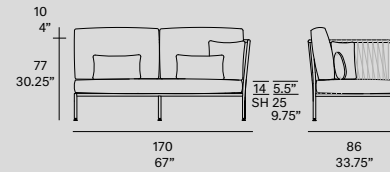

**C273 T**  
—  
Hand woven left chaise longue module

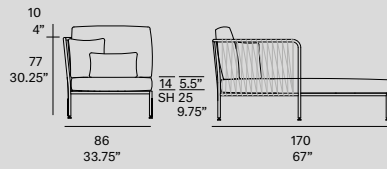

**C274 T**  
—  
Hand-woven right chaise longue module

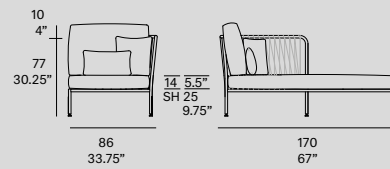

**C275 T**  
—  
Hand-woven corner module

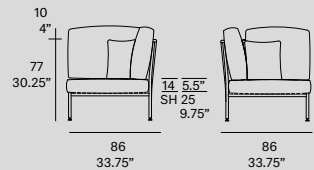

**C276 T**  
—  
Hand-woven short side module

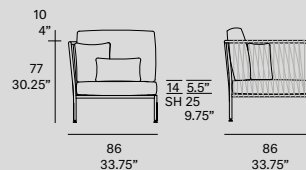

**C272 T**  
—  
Hand-woven central module

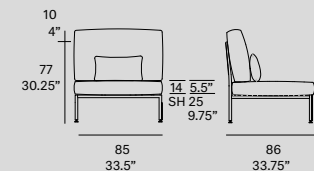

**C258 T**  
—  
Hand-woven dining armchair

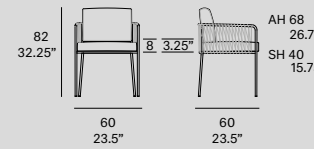

**C259 T**  
—  
Hand-woven barstool

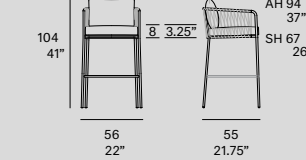

Frame:

- 100 white
- 111 FT graphite
- 102 FT light grey
- 108 FT oxide
- 109 FT champagne
- 110 FT bronze
- 113 FT sage

Rope:

- 501 black
- 509 taupe
- 510 SPK orange
- 511 SPK dark orange
- 513 SPK oxide
- 520 SPK sand
- 522 SPK concrete
- 524 SPK ivy
- 526 SPK turquoise
- 527 forest green

Cushions:

- G11
- G12
- G13

# nido

javier pastor, 2010/2019

**C250 T**  
—  
Hand-woven low armchair

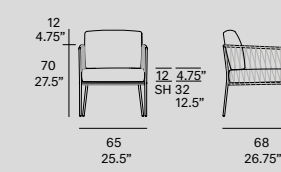

**C251 T**  
—  
Hand-woven armchair

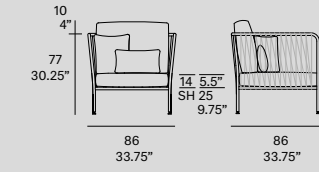

**C253 T**  
—  
Hand-woven sofa

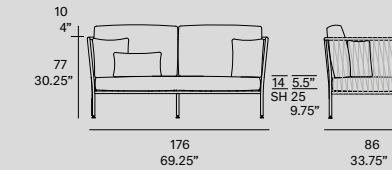

**C254 T**  
—  
XL hand-woven sofa

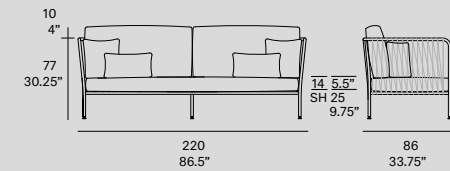

## composition examples

**NIDO 01 T**  
—  
Hand-woven modular composition

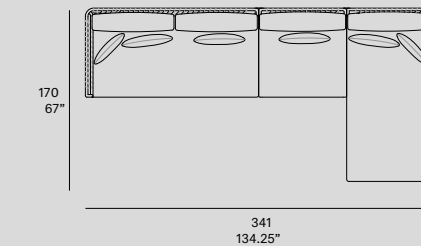

**NIDO 02 T**  
—  
Hand-woven modular composition

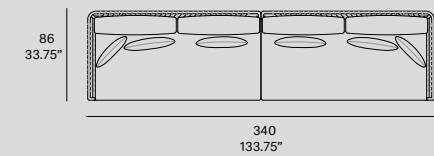

**NIDO 03 T**  
—  
Hand-woven modular composition

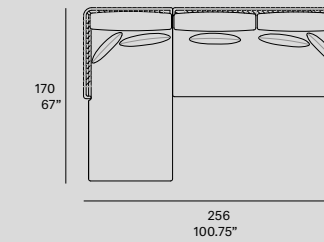

**NIDO 04 T**  
—  
Hand-woven modular composition

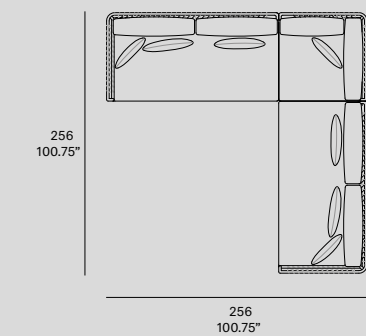

[en] Collection made of stainless steel tube, and finished with polyester powder. Hand-woven finish with high resistance rope 24 mm/0.94" wide. Possibility of creating a wide variety of layouts thanks to the modularity of its elements.

Frame:

- 100 white
- 111 FT graphite
- 102 FT light grey
- 108 FT oxide
- 109 FT champagne
- 110 FT bronze
- 113 FT sage

Rope:

- 501 black
- 509 taupe
- 510 SPK orange
- 511 SPK dark orange
- 513 SPK oxide
- 520 SPK sand
- 522 SPK concrete
- 524 SPK ivy
- 526 SPK turquoise
- 527 forest green

Cushions:

- G11
- G12
- G13