

Prices shown are not the final selling price.
To obtain the list price, multiply the price by 2.65.
Prices effective as June 2023.

VITAL PLUS 300

— By I+D+i Actiu —



INDIVIDUAL DESKS



TWIN, 4 PEOPLE AND PROGRESSIVE BENCH

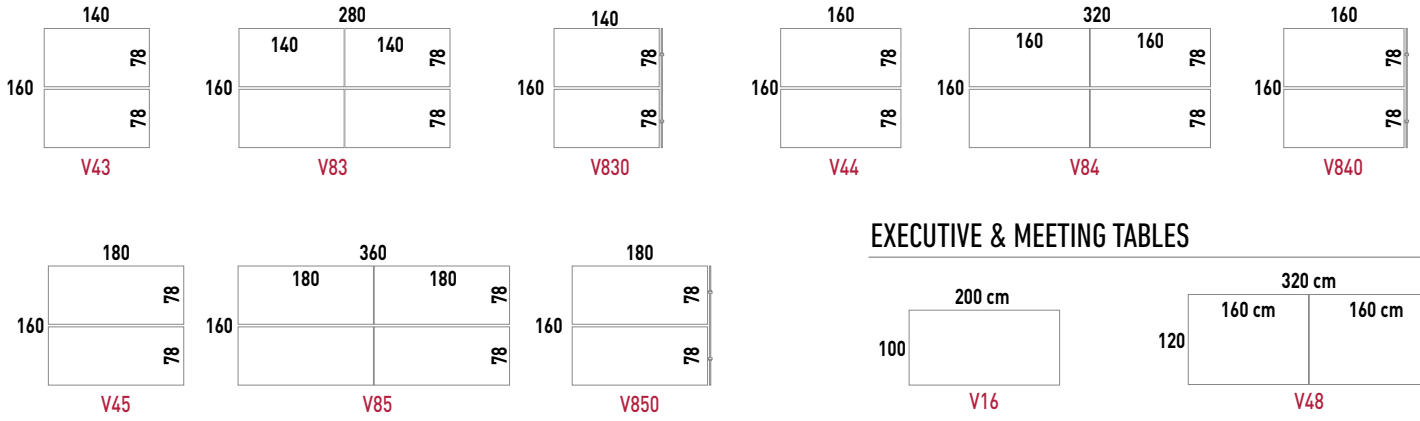

EXECUTIVE & MEETING TABLES

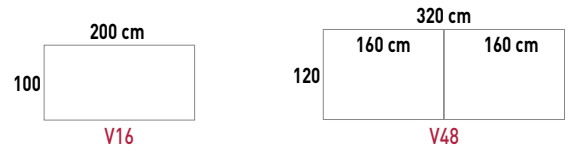

TRIPLE DESK - Vital PlusGEN

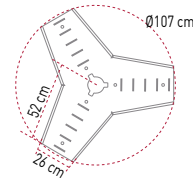
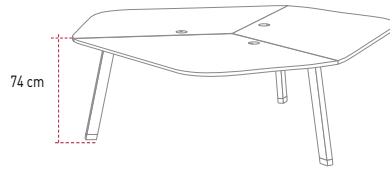
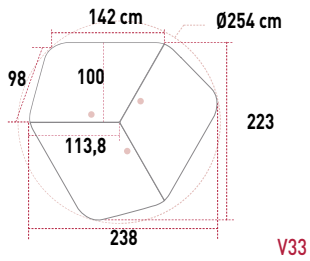

ELECTRIFICATION SYSTEMS



TECHNICAL FEATURES



INDIVIDUAL DESKS, TWIN, 4 PEOPLE AND PROGRESSIVE BENCH, EXECUTIVE & MEETING DESKS

- 1 Hot rolled, pickled steel legs with a 50x80 mm section that is 2mm thick
- 2 Strip of hot rolled, pickled steel with a 50x40 mm section that is 2mm thick.
- 3 Central support arm (Only for 1800 mm and larger desks or with Compact Laminate surface)
- 4 Moveable desk tops (only twin, 4 people and progressive bench). Opening and closing safety system located in the lower part of the desk top that allows its movement to be operated.
- 5 25mm MFC surface with rounded corners. 2 mm thick edges, applied with hot melt adhesive and rounded to R = 2 mm.
- 6 ABS ferrule with polypropylene levellers with non-slip patch.
- 7 Optional accessories, screens, cable outlets, cable channels, etc.

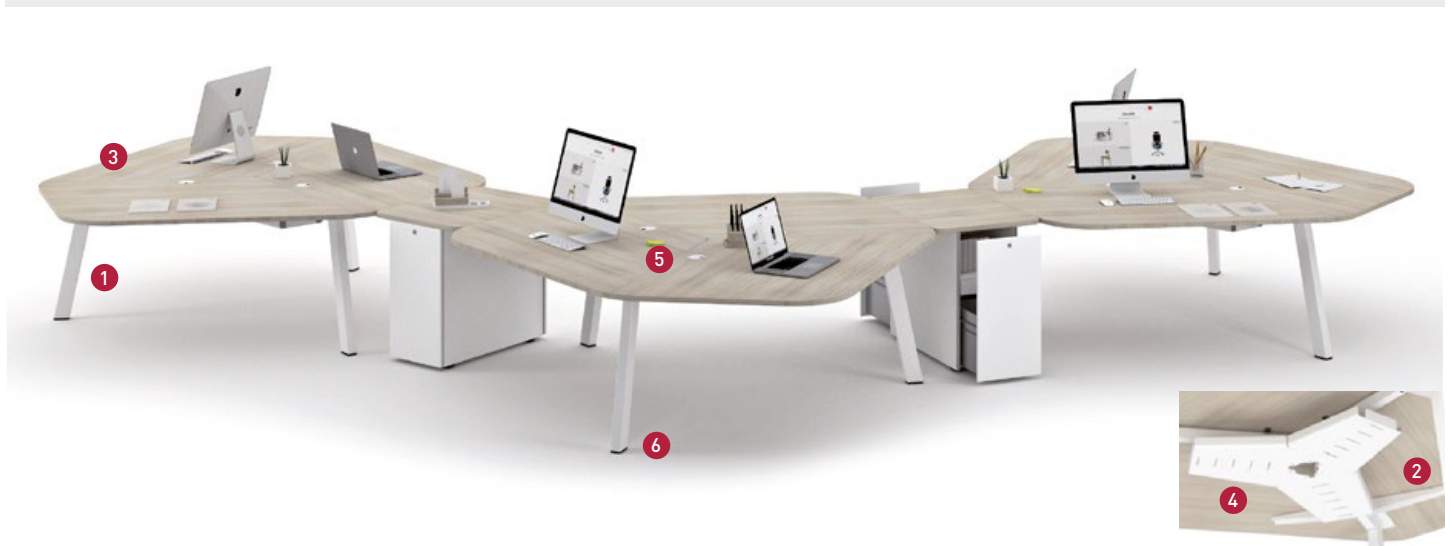

TRIPLE DESK - Vital Plus GEN

- 1 Hot rolled, pickled steel legs with a 50x80 mm section that is 2mm thick
- 2 Strip of hot rolled, pickled steel with a 50x40 mm section that is 2mm thick.
- 3 25mm MFC surface with rounded corners. 2 mm thick edges, applied with hot melt adhesive and rounded to R = 2 mm.
- 4 0.8 mm thick, sheet metal channel
- 5 80 mm diameter polypropylene cover to allow for the passage of cables to the lower area.
- 6 ABS ferrule with polypropylene levellers with non-slip patch



Painted structures

The structures in white or black finishes are manufactured by welding the different components, forming a unique leg structure.



Wood-like structures

The structures in wood like finishes (lime oak and chestnut), are offered disassembled and with an easy system of union by means of unique bolts that contributes great robustness to the set.

■ CABLE MANAGING

Vital Plus 300 is available with several cable managing options.



Steel metal channel 0,8 mm to 1 mm thick, large capacity for double desks.



Polystyrene riser cables



Sheet metal riser cables..

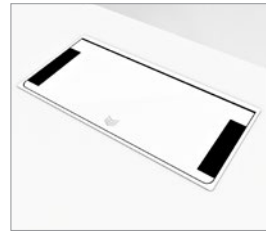

Wiring Access



"U" Access.

■ SCREENS



Desktop fixed screens.

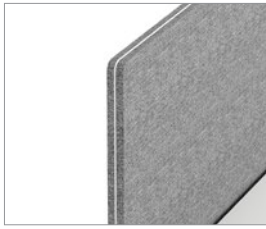

■ CPU HOLDER



CPU holder of 25-30 x 49 cm and 1,5 mm thick.

The CPU supports can only be used on the progression bridges of quadruple tables and double progression tables (V83F; V84F; V85F; V830F; V840F; V850F).

■ ACCESSORIES Vital Plus 300- GEN

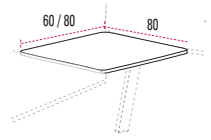
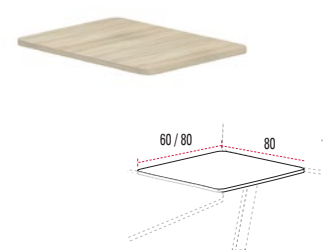
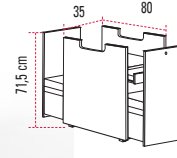
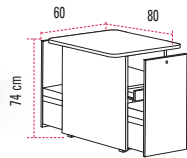

END PEDESTAL

- MFC 25 mm - Transition desk-top.
- MFC front & structure.
- Pedestal with acces to both faces
- 1 shelfe for face
- 1 Drawer for face
- 1 Filing drawer for face
- Total dimensions: 60 x 80 x 74 cm

TRANSITION PEDESTAL WITHOUT TOP

- Pedestal with acces to both faces
- Without top
- MFC front & structure.
- 1 shelfe for face
- 1 Drawer for face
- 1 Filing drawer for face
- Total dimensions: 35 x 80 x 74 cm

TRANSITION DESK-TOP

- MFC 25 mm - Transition desk-top or use with pedestal without top.
- Total dimensions:
 - 60 x 80 x 2,5 cm
 - 80 x 80 x 2,5 cm



- Board of 10+10 mm.
- Upholstered foam of 5 mm. Upholstered finishes: FabricT, Fabric F and Fabric M.
- Mobile screen. Anchoring system using an adaptable polycarbonate clamp.

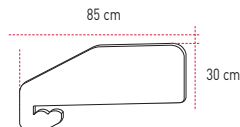

- Board of 19mm.
- Upholstered foam of 5 mm. Upholstered finishes: FabricT, Fabric F and Fabric M.
- Fixed screen. Anchoring system screwed to the surface of the table

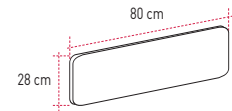

■ FINISHES

Top Finishes



Structure with smooth finishes

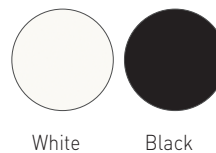

Structure with simulated woodgrain finishes





Vital Plus 300 - GEN

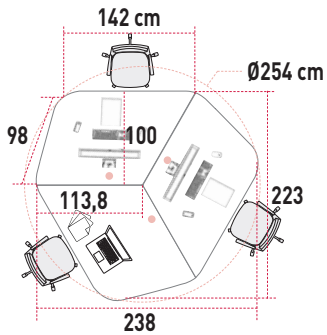

Vital Plus 300GEN, allows for different usability as a workstation:

- Use in Hot Desking (unassigned spaces), administrative spaces, workstations with laptops or light devices... where a large work surface is not needed for daily use
- Use in Fixed Stations (assigned spaces), open plan desking, workstations with computers and larger screens... where a large work surface is needed for daily use and the administration of different material.

■ EXAMPLE OF USE WITH LARGE SCREENS

27"



32"

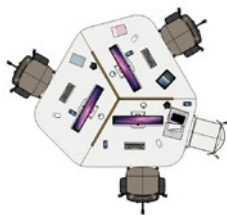

■ CONFIGURATION EXAMPLES

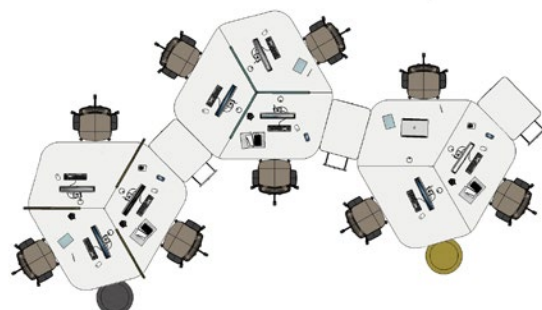
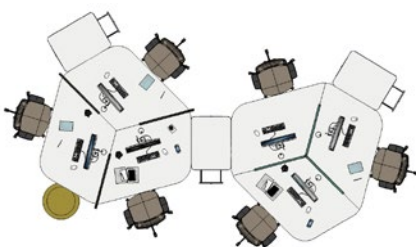

 Optional Access to wiring

 Included Access to wiring

VITAL 300

INDIVIDUAL DESKS

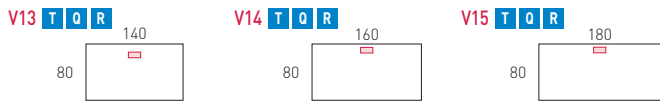

DOUBLE DESKS

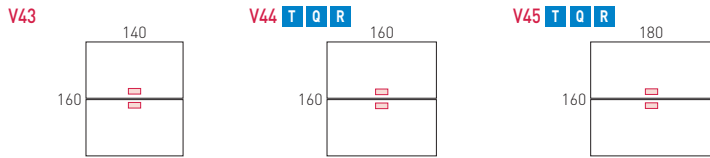

4 PEOPLE AND PROGRESSIVE BENCH

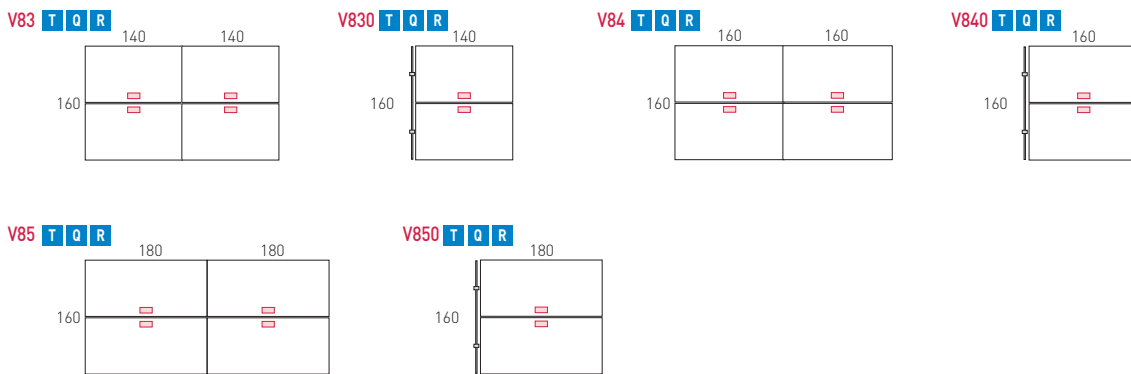



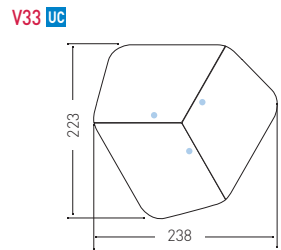

TRIPLE DESK - VITAL GEN



EXECUTIVE & MEETING TABLES



CABLE ACCESS DESKS			
T WIRING ACCESS	Q WIRING ACCESS	R WIRING ACCESS	U WIRING ACCESS
			
MAXIMUM OPENING: 90°	MAXIMUM OPENING: 110°	MAXIMUM OPENING: 180°	
<ul style="list-style-type: none"> • ABS injected lid • Frame injected in ABS • Injection-moulded polyamide clamping clips PA • Black bristle brush with zinc-plated plate profile • Polyamide guides for adjustment according to the thickness of the surface between 13 and 30 mm • Dimensions: 25 x 8,7 cm 	<ul style="list-style-type: none"> • Black die-cast aluminium frame • Die-cast aluminium lid • Aluminium guides for adjustment according to the thickness of the surface between 13 and 30 mm • Dimensions: 30,5 x 12,1 cm 	<ul style="list-style-type: none"> • Melamine lid of the same finish as the surface • Black Bristle Brush • Black die-cast aluminium frame • Aluminium guides for adjustment according to the thickness of the surface between 13 and 30 mm • Complete opening in 180° by means of hinges. • Dimensions: 30,5 x 12,1 cm 	<ul style="list-style-type: none"> • 80 mm diameter polypropylene cover for wiring to the bottom. • The upper part incorporates a small flange for small cable passage and allows the complete cover to be removed for cable passage. • Dimensions: Ø 8 cm

- Models with this standard cable access has the icon next to the code
- Desk price with the cable access is as per the attached table.
- To order different desks which the electrification access is not standard, **please check sales team.**
- To order desks with cable access, please add the corresponding letter according to the desired placement, at the end of the reference:

Front centered access	Left hand side	Right hand side	Centered access
T Q R U	TL QL RL UL	TR QR RR UR	TC QC RC UC

COMBINATIONS OF FINISHES OFFERED

IMPORTANT NOTE: The combination of wired access is carried out in the following way:
(If in any case you want the upper access in different finishing established, the customer must indicate it on the order.)

T / Q / U - WIRING ACCESS

Combinaciones Superficie/Estructura	Flip-up door / cover finish	
	White	Black
Surface: White Structure: Any Finish	●	
Surface: Any Finish - (Not White) Structure: White	●	
Surface: Any Finish - (Not White) Structure: Black		●

R WIRING ACCESS

Combinaciones Surface/Structure	Flip-up door / cover finish
	Finish Cover in the same colour as the surface
Surface: Any Finish Structure: Any Finish	●

IMPORTANT NOTE



Individual and twin operative desks with sliding top. It is not available to fix metal container for T cable access, **only metal cable channel.**

EXAMPLE OF AN ORDER

Desk model	Finish Structure	Finish Surface	Cable Access	Final Reference
V14F Individual Table	00 White Structure	00 White MFC	T Cable access	V14F000T

INDIVIDUAL TABLE

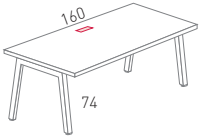

		V13	V14	V15		
Model Sizes (A x B)		80 	80 	80 		
		Levellers Height 74 cm V13F	Levellers Height 74 cm V14F	Levellers Height 74 cm V15F		
Structure	 White 00	529,20	557,20	582,40		
	 Black 08					
	 Lime Oak 01	+ 254,80	+ 254,80	+ 254,80		
	 Chesnut 03					
Surface	 White 00					
	 Coco Grey 15					
	 Lime Oak 11					
	 Light Oak 10					
	 Chesnut 07					
C. laminate	 White 30	+ 302,40	+ 308,00	+ 345,80		
Cable Access	Optional	MFC	T	+ 36,40	+ 36,40	+ 36,40
			Q	+ 72,80	+ 72,80	+ 72,80
			R	+ 95,20	+ 95,20	+ 95,20
	C. laminate		T	+ 36,40	+ 36,40	+ 36,40
			Q	+ 75,60	+ 75,60	+ 75,60

 Optional Access to wiring

 Cofificación necesaria para configurar referencia.
No suponen incremento de coste

EXAMPLE OF AN ORDER

Desk model	Finish Structure	Finish Surface	Cable Access	Final Reference
V43F Twin Desk	00 White Structure	00 White MFC	T Cable access	V43F0000T

TWIN DESK

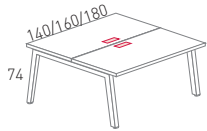

		V43	V44	V45		
Model Sizes (A x B)		140 160	160 160	180 160		
		Levellers Height 74 cm Sliding Tops V43F	Levellers Height 74 cm Sliding Tops V44F	Levellers Height 74 cm Sliding Tops V45F		
Structure	White	00	854,00	890,40	924,00	
	Black	08				
	Lime Oak	01	+ 268,80	+ 268,80	+ 268,80	
	Chesnut	03				
Surface	White	00				
	Coco Grey	15				
	Lime Oak	11				
	Light Oak	10				
	Chesnut	07				
C. laminate	White	30	+ 604,80	+ 616,00	+ 691,60	
Cable Access	Optional (2 Units)	MFC	T	+ 72,80	+ 72,80	+ 72,80
		Q	+ 145,60	+ 145,60	+ 145,60	
		R	+ 190,40	+ 190,40	+ 190,40	
	C. laminate	T	+ 72,80	+ 72,80	+ 72,80	
		Q	+ 151,20	+ 151,20	+ 151,20	

Optional Access to wiring

Cofificación necesaria para configurar referencia.

No suponen incremento de coste

EXAMPLE OF AN ORDER

Desk model	Finish Structure	Finish Surface	Cable Access	Final Reference
V83F Quadruple tables	00 White Structure	00 White MFC	T Cable Access	V83F0000T

4 PEOPLE WORKSTATIONS

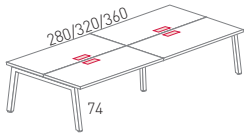

				V83	V84	V85
Model Sizes (A x B)				280 160	320 160	360 160
				Levellers Height 74 cm Sliding Tops V83F	Levellers Height 74 cm Sliding Tops V84F	Levellers Height 74 cm Sliding Tops V85F
Structure	White	00		1593,20	1695,40	1786,40
	Black	08				
	Lime Oak	01				
	Chesnut	03		+ 355,60	+ 355,60	+ 355,60
Surface	MFC	White	00			
		Coco Grey	15			
		Lime Oak	11			
		Light Oak	10			
		Chesnut	07			
	C. laminate	White	30			
Cable Access	Optional (4 Units)	MFC	T	+ 145,60	+ 145,60	+ 145,60
			Q	+ 291,20	+ 291,20	+ 291,20
			R	+ 380,80	+ 380,80	+ 380,80
	C. laminate	T	+ 145,60	+ 145,60	+ 145,60	
		Q	+ 302,40	+ 302,40	+ 302,40	

Optional Access to wiring

Cofificación necesaria para configurar referencia.
No suponen incremento de coste

EXAMPLE OF AN ORDER

Desk model	Finish Structure	Finish Surface	Cable Access	Final Reference
V830F Progression tables	00 White Structure	00 White MFC	T Cable Access	V830F0000T

PROGRESSIVE BENCH

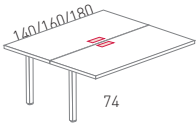

Model Sizes (A x B)				V830 140 160	V840 160 160	V850 180 160
				Levellers Height 74 cm Sliding Tops V830F	Levellers Height 74 cm Sliding Tops V840F	Levellers Height 74 cm Sliding Tops V850F
Structure		White	00	714,00	765,80	809,20
		Black	08			
		Lime Oak	01	+ 96,60	+ 96,60	+ 96,60
		Chesnut	03			
Surface	MFC		White			
			Coco Grey	15		
			Lime Oak	11		
			Light Oak	10		
			Chesnut	07		
	C. laminate		White	30	+ 604,80	+ 616,00
Cable Access	Optional (2 Units)	MFC	T	+ 72,80	+ 72,80	+ 72,80
			Q	+ 145,60	+ 145,60	+ 145,60
			R	+ 190,40	+ 190,40	+ 190,40
	C. laminate		T	+ 72,80	+ 72,80	+ 72,80
			Q	+ 151,20	+ 151,20	+ 151,20

Optional Access to wiring

Cofificación necesaria para configurar referencia.
No suponen incremento de coste

EXAMPLE OF AN ORDER

Desk model	Finish Structure	Finish Surface	Final Reference
V33F Triple Desk	00 White Structure	00 White MFC	V33F0000

TRIPLE DESK - GEN

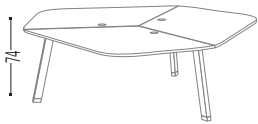

Model Sizes (A x B)		V33 	
		LEVELLERS Height 74 cm ACCESS TO WIRING Y TELÉCANAL V33F	
Structure		White	00
		Black	08
		Lime Oak	01
		Chesnut	03
		1356,60	
		++ 240,80	
Surface MFC		White	00
		Coco Grey	15
		Lime Oak	11
		Light Oak	10
		Chesnut	07
		Black	03
		+ 705,60	



Metal cable tray included

Included Access to wiring

Cofificación necesaria para configurar referencia.

No suponen incremento de coste

EXAMPLE OF AN ORDER

Desk model	Finish Structure	Finish Surface	Cable Access	Final Reference
V16F Twin desk Vital 300	00 White Structure	00 White MFC	T Cable Access T	V16F000T

EXECUTIVE & MEETING TABLES

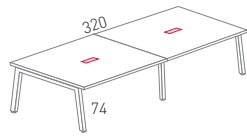
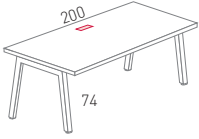

Model Sizes (A x B)				V16 200 100	V48 320 120		
				LEVELLERS Height 74 cm V16F	LEVELLERS Height 74 cm V48F		
Structure		White	00	674,80	1174,60		
		Black	08				
		Lime Oak	01	+ 264,60			
		Chesnut	03				
Surface	MFC		White				
			Coco Grey			15	
			Lime Oak			11	
			Light Oak			10	
			Chesnut			07	
		Dark Oak	14				
C. laminate		White	30	+ 515,20	+ 0,00		
Cristal		White	52	+ 781,20	+ 0,00		
		Black	58				
Cable Access	Optional	MFC	1 Ud	T	+ 36,40		
				Q	+ 72,80		
				R	+ 95,20		
			2 Uds	QC		+ 145,60	
				RC		+ 190,40	
			C. laminate	1 Ud	T	+ 36,40	
		Q			+ 75,60		
			2 Uds	QC			

Optional Access to wiring

Coding required to configure reference.
They do not mean an increase in cost

CABLE ACCESS CANNOT BE INCORPORATED INTO TABLES WITH A GLASS SURFACE

EXAMPLE OF AN ORDER

Model	Front & Structure Finish	Top Finish	Final Reference
V79 Pedestal for end of layouts	0 MFC White	00 MFC White	V79000

ACCESSORIES FOR VITAL 300

V79



TW77



TW206 / TW210



		V79	TW77	TW206	TW210
Model Sizes (A x B)					
		Pedestal with top Pedestal for end of layouts. Can be opened from both sides. Shelve + drawer + Filing drawer V79	Pedestal without top Pedestal to be used under extension table tops with cable driving and access from both sides. Shelve + drawer + Filing drawer USE WITH EXTENSION TABLE TOP TW77	Extension table top to be used: - As an additional extension top (supports up to 20kg) - With a pedestal without top 4 linking brackets included TW206	Extension table top to be used: - As an additional extension top (supports up to 20kg) - With 2 pedestals without top 4 linking brackets included TW210
Front & Structure	MFC	White 0			
Top	MFC	White 00	784,00	760,20	120,40
		Coco Grey 15			
		Lime Oak 11			
		Light Oak 10			
		Chesnut 07			
		Black 03			
		+ 51,80		+ 51,80	+ 78,40

ELECTRIFICATION SYSTEMS

Model Sizes (A x B)		
PROGRESSION CABLE TRAY IN TRIPLE DESK, TO CONNECT TO TRANSITION. 780 MM TRIPLE DESK - GEN 6345		
Finish	White 0	100,80
	Black 8	

- Coding required to configure reference.
They do not mean an increase in cost
- Combination not available.

EXAMPLE OF AN ORDER

Model	Finish	Final Reference
FVP34 L=124 cm Modesty panel for 140 cm desks.	00 White MFC	FVP3400

MODESTY PANEL (Only for individual desks)

Model Sizes (A x B)			MFC Modesty panel			Steel Modesty Panel			Steel Modesty Panel			Aluminium Modesty Panel	
			L=124 cm For 140 cm desks FVP34	L=144 cm For 160 cm desks FVP35	L=164 cm For 180 cm desks FVP36	L=124 cm For 140 cm desks FVP44	L=144 cm For 160 cm desks FVP45	L=164 cm For 180 cm desks FVP46	L=124 cm For 140 cm desks FVP64	L=144 cm For 160 cm desks FVP65	L=164 cm For 180 cm desks FVP66	L=164 cm For 180 cm desks FVP76	
MFC		White	00	77,00	81,20	85,40							
		Coco Grey	15										
		Black	08										
		Lime Oak	11										
		Light Oak	10										
		Chestnut	07										
Steel		White	00				145,60	152,60	161,00	144,20	148,40	159,60	
		Black	08										
Aluminium		White	60									249,20	
Brackets		White	B										
		Black	N										

ACCESSORIES

Model Sizes (A x B)			ATX CPU Width adjustment. From 14 to 22cm 50704		SLIM CPU Width adjustment. From 9 to 14cm 50705		CABLE SPINE (METAL) Bench, 4 people or any bench progressive desk 5070		CABLE SPINE (METAL) Bench, 4 people or any bench progressive desk 5071		CABLE SPINE (METAL) 4 people or any bench progressive desk 5073		CABLE SPINE (POLYSTYRENE) Minimum units order: 3 units 39525		Braided textile wrap with zipper for quick and easy installation. Offers additional protection against flames and abrasion	
			127,40		113,40		112,00		134,40		210,00		26,60		Pack 1 Unit	Pack 4 Units
Finish		White	0											39431		39434
		Black	8											36,40		131,60



The CPU supports can only be used on the progression bridges of quadruple tables and double progression tables (V83F; V84F; V85F; V830F; V840F; V850F).



Coding required to configure reference.
They do not mean an increase in cost
 Combination not available.

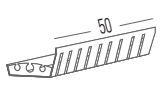
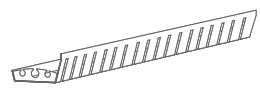

EXAMPLE OF AN ORDER

Model	Finish	Final Reference
5749 500mm Cable tray Individual desks	0 White	57490

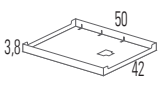
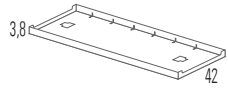
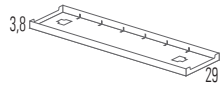
ELECTRIFICATION SYSTEMS

Model Sizes (A x B)					
		500mm CABLE TRAY INDIVIDUAL DESKS 5769	LARGE CAPACITY CABLE TRAY FOR INDIVIDUAL DESKS COMPLETE LENGTH		
			L=124 cm For 140 cm desks 5762	L=144 cm For 160 cm desks 5764	L=164 cm For 180/200 cm desks 5766
Finish	 White	53,20	70,00	77,00	79,80
	 Black				

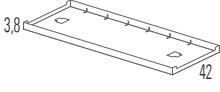
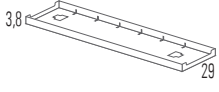
Model Sizes (A x B)								
		500mm CABLE TRAY - BENCH DESKS 5789	42 cm WIDTH LARGE CAPACITY CABLE TRAY COMPLETE LENGTH			29 cm WIDTH LARGE CAPACITY CABLE TRAY COMPLETE LENGTH		
			L=124 cm For 140 cm desks 5782	L=144 cm For 160 cm desks 5784	L=164 cm For 180 cm desks 5786	L=124 cm For 140 cm desks 6082	L=144 cm For 160 cm desks 6084	L=164 cm For 180 cm desks 6086
Finish	 White	75,60	121,80	130,20	134,40	105,00	112,00	120,40
	 Black							

Model Sizes (A x B)					
		42 cm WIDTH LARGE CAPACITY CABLE TRAY RECESSED LENGTH		29 cm WIDTH LARGE CAPACITY CABLE TRAY RECESSED LENGTH	
		L=104 cm For 140cm/160cm desks 5780	L=124 cm For 180 cm desks 5782	L=104 cm For 140cm/160cm desks 6080	L=124 cm For 180 cm desks 6082
Finish	 White	114,80	121,80	96,60	105,00
	 Black				

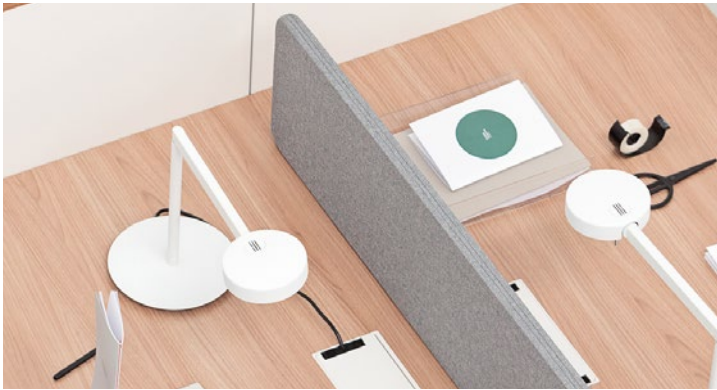

■ Desks mounted screens

Desk-Mounted screens, different sizes available, fixing kits and finishes. Easy to be adapted to any surface. They provide visual contact but at the same time privacy. Twin desks with electrification system have their own desk-mounted screens (**D50 Serie for Vital or Arkitek**)

■ DESK MOUNTED SCREENS OFFER

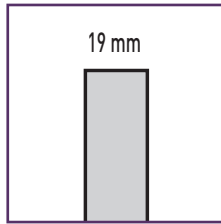

MFC SCREEN - e=19mm

19 mm thick Chipboard

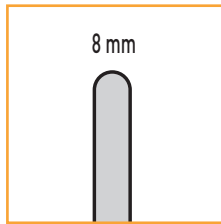

GLASS SCREEN - e=8mm

Laminated Security Glass (4+4 mm) / Tempered glass (8 mm)

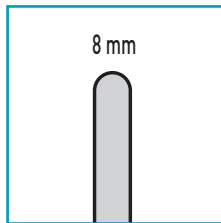

METHACRYLATE SCREEN - e=8mm

8 mm thick White Methacrylate

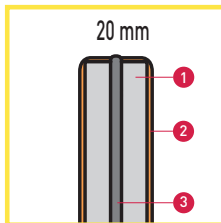

UPHOLSTERED SCREEN WITH FLEXIBLE PROFILE - e=20mm

- 1 19 mm thick Chipboard
- 2 Different fabrics available glued using water glue.
- Optional acoustic or fire resistant fabrics for projects.
- 3 8mm thick flexible Profile

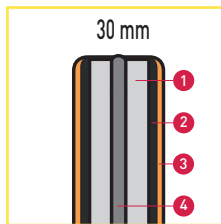

UPHOLSTERED SCREEN WITH FLEXIBLE PROFILE - e=30mm





- 1 19 mm thick Chipboard
- 2 Foam thickness e= 5 mm and 60 Kg/m³ density (etotal= 30 mm)
- 3 Different fabrics available glued using water glue.
- Optional acoustic or fire resistant fabrics for projects.
- 4 8mm thick flexible Profile



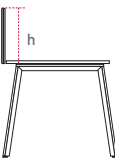

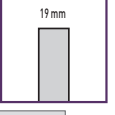

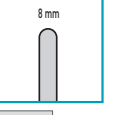

EXAMPLE OF AN ORDER FOR DIVIDER

Divider Model	Bracket finish	Divider finish	Final Reference
ZZ851 Screens for individual tables Pack 1 Unit	0 White bracket	2T82 Upholstered finish Fabric T	ZZ85102T82

SCREENS FOR INDIVIDUAL DESKS



				
31	28	28	31	38
MFC	Methacrylate	Glass	Upholstered divider e= 20 mm	Upholstered divider e=30 mm

Model Dimensions (A x B)		ZH84	ZH85	ZH86						
		130	150	170						
		For 140 cm desk	For 160 cm desk	For 180 cm desk						
Units / Pack		Pack 1 Ud.	Pack 2 Uds.	Pack 1 Ud.	Pack 2 Uds.	Pack 1 Ud.	Pack 2 Uds.			
Base Reference		ZH841	ZH842	ZH851	ZH852	ZH861	ZH862			
Bracket finish	WHITE	0								
	SILVER	2								
	BLACK	8								
Type of surface	For use with Compact laminate surfaces you have to add a "F" at code	F	15,40	30,80	15,40	30,80	15,40	30,80		
MFC DIVIDER e = 19 mm - h= 31 cm										
MFC		White	00	78,40	144,20	82,60	155,40	89,60	168,00	
		Coco Grey	15	78,40	144,20	82,60	155,40	89,60	168,00	
		Black	08	78,40	144,20	82,60	155,40	89,60	168,00	
METHACRYLATE DIVIDER e = 8 mm - h= 28 cm										
Methacrylate		White	90	166,60	320,60	173,60	336,00	219,80	431,20	
UPHOLSTERED DIVIDERS WITH FLEXIBLE PROFILE e= 20 mm - h= 31 cm										
Upholstered divider e= 20mm	GROUP 0		Group T	2T--	110,60	212,80	124,60	235,20	134,40	254,80
			Group AE	2AE--	149,80	291,20	168,00	322,00	184,80	355,60
	GROUP 2		Group D	2D--	166,60	320,60	183,40	352,80	204,40	397,60
			Group M	2M--						

EXAMPLE OF AN ORDER FOR DIVIDER

Divider Model	Bracket finish	Divider finish	Final Reference
ZV241 Screen for individual desk 140 cm Pack 1 units	0 White	2T82 Group T Upholstered	ZV24102T82

SCREENS FOR TWIN DESKS

		MFC		Methacrylate		Glass		Upholstered divider e= 20 mm		Upholstered divider e=30 mm	
		31	28	28	28	31	38				
Model Dimensions (A x B)		ZV24 130		ZV25 150		ZV26 170					
		For 140 cm desk		For 160 cm desk		For 180 cm desk					
Units / Pack		Pack 1 Ud.	Pack 2 Uds.	Pack 1 Ud.	Pack 2 Uds.	Pack 1 Ud.	Pack 2 Uds.				
Base Reference		ZV241	ZV242	ZV251	ZV252	ZV261	ZV262				
Bracket finish	WHITE	0									
	BLACK	8									
MFC DIVIDER e = 19 mm - h = 31 cm											
MFC		White	00	82,60	155,40	88,20	165,20	95,20	180,60		
		Coco Grey	15	82,60	155,40	88,20	165,20	95,20	180,60		
		Black	08	82,60	155,40	88,20	165,20	95,20	180,60		
METHACRYLATE DIVIDER e = 8 mm - h = 28 cm											
Methacrylate		White	90	172,20	333,20	183,40	352,80	228,20	443,80		
GLASS DIVIDER e = 8 mm - h = 28 cm											
Glass		Frosted	50	236,60	459,20	246,40	481,60	278,60	544,60		
		White	52	288,40	562,80	316,40	618,80	355,60	698,60		
UPHOLSTERED DIVIDERS WITH FLEXIBLE PROFILE e= 20 mm - h= 31 cm											
Upholstered divider - e=20 mm	GROUP 0		Group T	2T--	120,40	225,40	131,60	247,80	140,00	270,20	
	GROUP 1		Group AE	2AE--	158,20	301,00	176,40	337,40	191,80	373,80	
	GROUP 2		Group D	2D--	172,20	333,20	189,00	365,40	211,40	411,60	
			Group M	2M--							
UPHOLSTERED DIVIDERS WITH FLEXIBLE PROFILE e= 30 mm - h= 38 cm											
Upholstered divider - e=30 mm	GROUP 0		Group T	3T--	190,40	371,00	204,40	397,60	232,40	450,80	
	GROUP 1		Group AE	3AE--	226,80	443,80	264,60	518,00	312,20	610,40	
	GROUP 2		Group D	3D--	239,40	462,00	295,40	575,40	354,20	694,40	
			Group M	3M--							

EXAMPLE OF AN ORDER FOR DIVIDERS TO USE WITH TRIPLE DESK





Divider Model	Divider Finish	Final Reference
ZMV161 Mobile Divider for Triple desks Pack 1 Unit	T82 Upholstered finish Fabric T	ZMV161T82

TABLE TOP DIVIDERS FOR VITAL PLUS 300 - TRIPLE DESK 120°

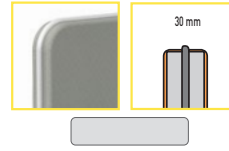

- Divider Upholstered:
- Board of 19mm.
 - 5mm foam (60kg/m3) on each side.
 - Upholstered finishes: Fabric T, AE, AO, D and M.
 - 8mm thick flexible Profile.







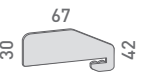
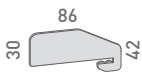

Model Dimensions (A x B)		ZWN30 FOR TRIPLE DESK 80 28  FABRIC		
		UPHOLSTERED DIVIDER FOR TRIPLE DESK VITAL PLUS 300 - GEN 80 cm Large		
Units / Pack		Pack 3 Units ZWN303		
UPHOLSTERED DIVIDER e= 30 mm - h= 28 cm				
Upholstered	GROUP 0	 Fabric T	3T-- 403,20	
	GROUP 1	 Fabric AE	3AE-- 446,60	
	GROUP 2	 Fabric D	3D--	477,40
		 Fabric M	3M--	

TOP MOBILE DIVIDER FOR VITAL PLUS 300 - TRIPLE DESK 120°



- Mobile Divider Upholstered:
- Board of 10+10mm.
 - Internal reinforcement plate 3mm thick, which gives it greater stability.
 - 5mm foam (60kg/m3) on each side.
 - Upholstered finishes: Fabric T, AE, AO, D and M.
 - 8mm thick flexible Profile.
 - Anchoring system using an adaptable polycarbonate clamp for surfaces of 13/19 and 25 mm.

Model Dimensions (A x B)		ZMV16 		ZMV18 			
		MOBILE UPHOLSTERED DIVIDER 67 cm Large		MOBILE UPHOLSTERED DIVIDER 86 cm Large			
Units / Pack		Pack 1 Unit ZMV161	Pack 2 Units ZMV162	Pack 1 Unit ZMV181	Pack 2 Units ZMV182		
Upholstered	GROUP 0	 Fabric T	T-- 319,20	632,80	347,20	687,40	
	GROUP 1	 Fabric AE	AE--	337,40	673,40	373,80	737,80
		 Fabric AO	AO--				
	GROUP 2	 Fabric D	D--	344,40	683,20	379,40	751,80
		 Fabric M	M--				