



EXO

by PerezOchando

EXO collection is composed of tables, consoles and TV supports. It is characterized by a metal structure as an essential part of its design. A unique elegant set form is created via its perfect combination of materials.



Coffee table with ash oak finish, stone lacquer and micro-textured black thermo-lacquered structure by PerezOchando from EXO collection, code EXO-26, 120X60x40 cm.



Occasional and coffee table

The different table sizes and finishes make it easier to adapt EXO in the home, and at the same time, in any kind of facility. It is a functional and lightweight solution that can be integrated in every interior.



Coffee table with ash oak finish, stone lacquer and micro-textured black thermo-lacquered structure by PerezOchando from EXO collection, code EXO-22, 120x120x40 cm.



Coffee table with light oak finish, ocean lacquer and micro-textured black thermo-lacquered structure by PerezOchando from EXO collection, code EXO-00, 100x100x40 cm.



It is available in different sizes that make it suitable in different rooms. Due to the wide range of finishes that we offer, it can be easily integrated into any interior.





PerezOchando coffee table with toasted oak finish, ocean lacquer and micro-textured black thermo-lacquered structure from the EXO collection, code EXO-26, 120x60x40 cm.
 Coffee table with mint lacquer finish by PerezOchando from EXO collection, code EXO-66, 60x60x50 cm

EXO PerezOchando

EXO coffee table stands out for its potential. It can be included in different customised projects by combining various pieces from the collection.



EXO-26, 120x60x40 cm



EXO-26, 120x60x40 cm

EXO PerezOchando



EXO-26, 120x60x40 cm
EXO-66, 60x60x50 cm



EXO-22, 120x120x40 cm

Finishes

EXO occasional and coffee table have exceptional proportions and design. They are composed of a top available in different finishes such as oak, walnut, black glass or lacquer together with its black micro-textured thermo-lacquered metal structure.

			
Piedra Stone RAL 7044	Arena Sand NCS S2005-Y20R	Visión Taupe NCS S4005-Y20R	Grafito Graphite RAL 7022
			
Niebla Fog NCS S5005-B20G	Océano Ocean NCS S7010 B10G	Pizarra Slate NCS S8500-N	Negro Black
			
Menta Mint NCS S3010 G20Y	Oliva Olive NCS S6010 G10Y	Bosque Forest NCS S7010-B90G	Blanco White
			
Teja Tile NCS S5030 Y90R	Roble natural Natural oak	Roble claro Light oak	Roble teñido wengue Wengue stained oak
			
Roble teñido ceniza Ash stained oak	Roble teñido tostado Toasted stained oak	Nogal natural Natural walnut	Cristal negro Black glass

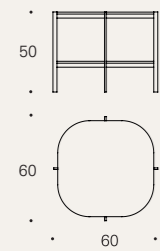

Top: 60x60 cm
Metal leg (1): 2,5 cm
Final size: 65x65 cm

EXO-66 60x60x50 cm 0,290 m³ 19 Kg

Lacquer top / Micro-textured black thermo-lacquered structure

Oak top / Micro-textured black thermo-lacquered structure

Shelf finish: Lacquer

Lacquer structure option*

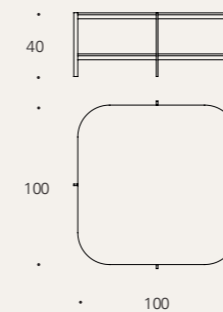

Top: 100x100 cm
Metal leg (1): 2,5 cm
Final size: 105x105 cm

EXO-00 100x100x40 cm 0,577 m³ 48 Kg

Lacquer top / Micro-textured black thermo-lacquered structure

Oak top / Micro-textured black thermo-lacquered structure

Shelf finish: Lacquer

Lacquer structure option*

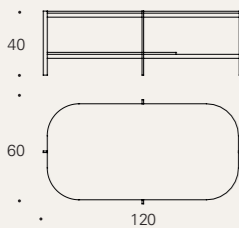

Top: 120x60 cm
Metal leg (1): 2,5 cm
Final size: 125x65 cm

EXO-26 120x60x40 cm 0,437 m³ 27 Kg

Lacquer top / Micro-textured black thermo-lacquered structure

Oak top / Micro-textured black thermo-lacquered structure

Black glass top / Micro-textured black thermo-lacquered structure

Walnut top / Micro-textured black thermo-lacquered structure

Shelf finish: Lacquer

Lacquer structure option*

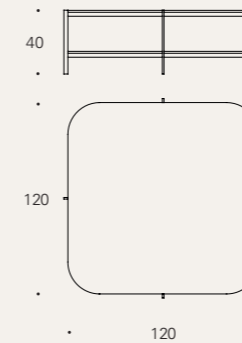

Top: 120x120 cm
Metal leg (1): 2,5 cm
Final size: 125x125 cm

EXO-22 120x120x40 cm 0,801 m³ 60 Kg

Lacquer top / Micro-textured black thermo-lacquered structure

Oak top / Micro-textured black thermo-lacquered structure

Shelf finish: Lacquer

Lacquer structure option*

Acabados solo para la medida 120x60:

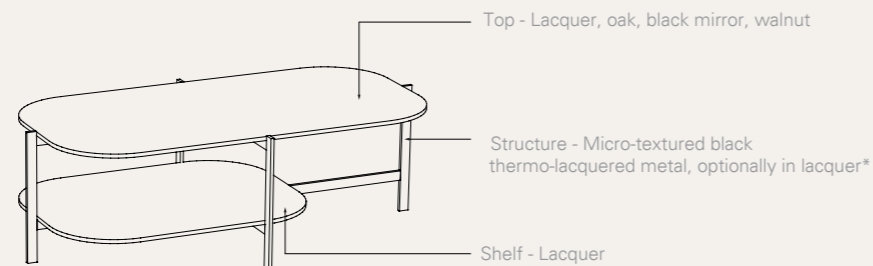

Occasional tables / Coffee tables

Acabados para medidas 60x60, 100x100 y 120x120:

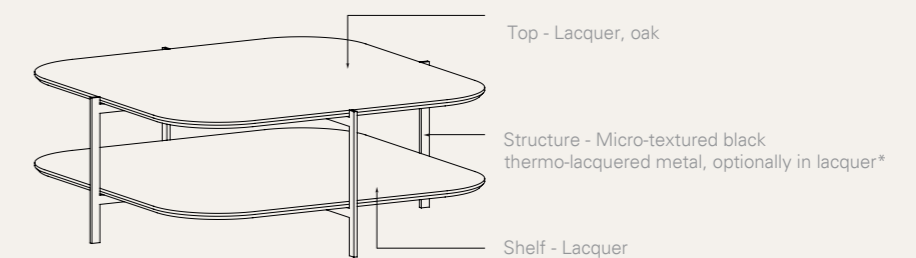

Occasional tables / Coffee tables



TV support with black lacquer finish and micro-textured black thermo-lacquered structure by PerezOchando from EXO collection, code EXO-64, 160x40x40 cm.



TV support

The EXO collection includes a TV support, which measures and finishes make it easy to adapt it to any space. This solution forms part of a very versatile collection.



EXOV-64, 160x40x40 cm

It is available in four different sizes that adapt this TV support to the requirements of every room. Given the wide range of colours that we offer, it can be integrated in any interior.





EXOV-64, 160x40x40 cm

Finishes

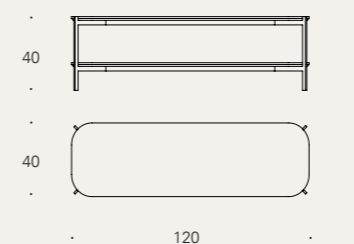
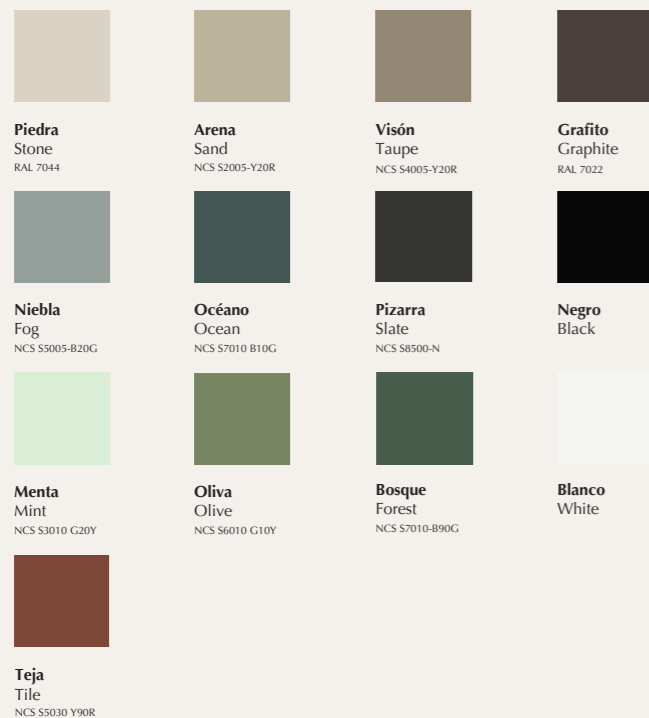
EXO TV support owns an extraordinary design and proportions. It is composed of a top with lacquer finish, including a wide range of colours together with a micro-textured black thermo-lacquered metal structure.





EXOV-24 120x40x40 cm  0,292 m³  20 Kg

Lacquer top / Micro-textured black thermo-lacquered structure

Shelf finish: Lacquer

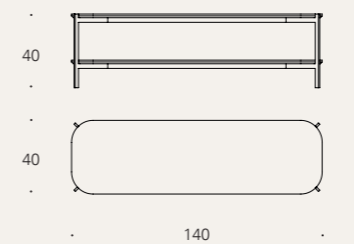
Lacquer structure option*





EXOV-44 140x40x40 cm  0,338 m³  25 Kg

Lacquer top / Micro-textured black thermo-lacquered structure

Shelf finish: Lacquer

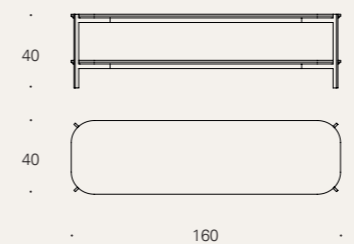
Lacquer structure option*





EXOV-64 160x40x40 cm  0,369 m³  32 Kg

Lacquer top / Micro-textured black thermo-lacquered structure

Shelf finish: Lacquer

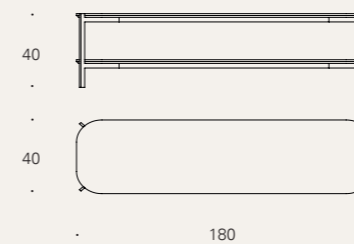
Lacquer structure option*



EXOV-84 180x40x40 cm  0,431 m³  40 Kg

Lacquer top / Micro-textured black thermo-lacquered structure

Shelf finish: Lacquer

Lacquer structure option*

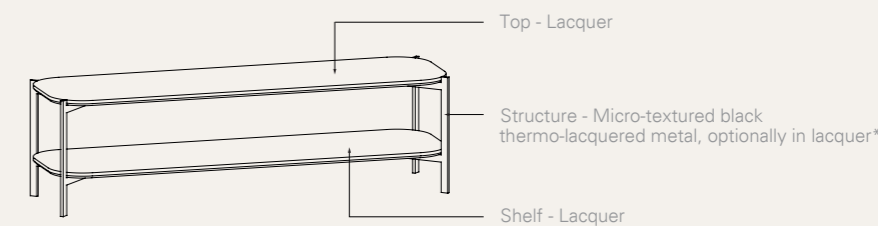



Console

EXO console is a singular part of the collection that stands out as a functional and lightweight solution that can be adapted to any interior.



Console with taupe lacquer finish and micro-textured black thermo-lacquered structure by PerezOchando from EXO collection, code EXOY-23, 120x35x74 cm.



EXO can be located in hallways and house entrances resulting as a really useful solution. It is a console that combines practicality and design in its own concept.



EXOY-23, 120x35x74 cm



“The range of shapes, sizes and finishes make it easier to adapt it to different spaces in homes and facilities.”

PerezOchando -

Finishes

Tops are offered in oak and lacquer, making it possible to adapt the console to the needs of each room. The structure can optionally be lacquered for easy integration into any interior.

			
Piedra Stone RAL 7044	Arena Sand NCS S2005-Y20R	Visón Taupe NCS S4005-Y20R	Grafito Graphite RAL 7022
			
Niebla Fog NCS S5005-B20G	Océano Ocean NCS S7010 B10G	Pizarra Slate NCS S8500-N	Negro Black
			
Menta Mint NCS S3010 G20Y	Oliva Olive NCS S6010 G10Y	Bosque Forest NCS S7010-B90G	Blanco White
			
Teja Tile NCS S5030 Y90R	Roble natural Natural oak	Roble claro Light oak	Roble teñido wengue Wengue stained oak
			
Roble teñido ceniza Ash stained oak	Roble teñido tostado Toasted stained oak		

The top finishes make it easier to adapt EXO both in the home and in facilities. It is a functional solution that creates the character of the atmosphere.



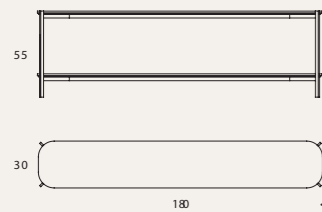

EXOY-83 180x30x55 cm 0,443 m³ 27 Kg

Lacquer top / Micro-textured black thermo-lacquered structure

Oak top / Micro-textured black thermo-lacquered structure

Shelf finish: Lacquer or oak

Option lacquer structure*

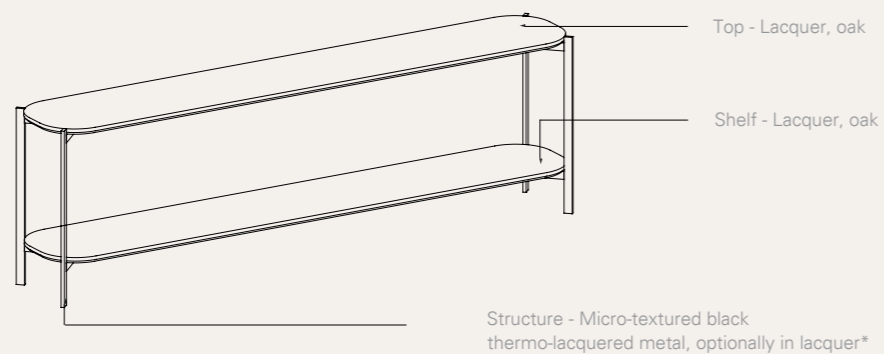

Occasional console table

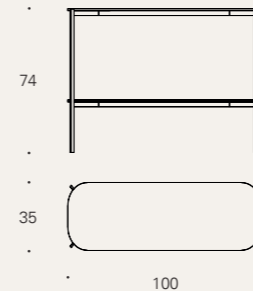

EXOY-03 100x35x74 cm 0,373 m³ 20 Kg

Lacquer top / Micro-textured black thermo-lacquered structure

Oak top / Micro-textured black thermo-lacquered structure

Shelf finish: Lacquer

Lacquer structure option*

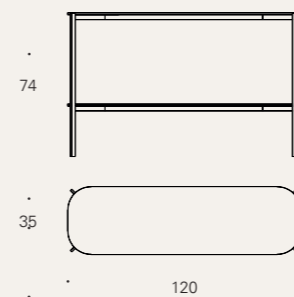

EXOY-23 120x35x74 cm 0,443 m³ 22 Kg

Lacquer top / Micro-textured black thermo-lacquered structure

Oak top / Micro-textured black thermo-lacquered structure

Shelf finish: Lacquer

Lacquer structure option*

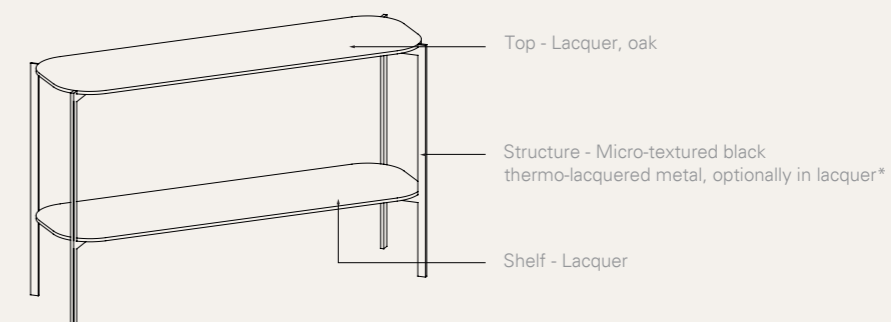

Console

Occasional and coffee table

EXO Round is the extension of EXO collection. The incorporation of new finishes such as statuario ceramic and marble make it adaptable in every atmosphere.



Coffee table with white marble finish, ash oak and micro-textured black thermo-lacquered structure by PerezOchando from the Exo Round collection, code EXO-24R, Ø120x40 cm.

Coffee tables in white and black marbles, ash oak and black lacquer shelf finish. Micro-textured black thermo-lacquered structure by PerezOchando from the Exo Round collection, code EXO-24R and EXO-04R, Ø120x40 cm and Ø100x40 cm.



Coffee table with ash oak finish, graphite lacquer and micro-textured black thermo-lacquered structure by PerezOchando from EXO Round collection, code EXO-04R, Ø100x40 cm.



Its metallic structure is an essential part of the design which, together with a top and a shelf, create an elegant and singular set.



PerezOchando white marble and tile lacquer coffee table from EXO Round collection, code EXO-74R, Ø70x45 cm.



Top, side table with white marble and taupe lacquer finish by PerezOchando from EXO Round collection, code EXO-55R, Ø55x55 cm.

Side table with black glass finish, stone lacquer and micro-textured black thermo-lacquered structure by PerezOchando from EXO Round collection, code EXO-55R, Ø55x55 cm.



EXO Round brings warmth and elegance to every space. Thanks to its variety of finishes and measures it can be included in any contract project.



EXO-74R, Ø70x45 cm



EXO-74R, Ø70x45 cm



EXO-74R, Ø70x45 cm



EXO-04R, Ø100x40 cm

Finishes

EXO Round collection is characterized by its different ways of combining finishes. Consisted of a top with alternative finishes like lacquer, oak, marble, black glass, statuario ceramic together with a micro-textured black thermo-lacquered metal structure.

			
Piedra Stone RAL 7044	Arena Sand NCS S2005-Y20R	Visón Taupe NCS S4005-Y20R	Grafito Graphite RAL 7022
			
Niebla Fog NCS S5005-B20G	Océano Ocean NCS S7010 B10G	Pizarra Slate NCS S8500-N	Negro Black
			
Menta Mint NCS S3010 G20Y	Oliva Olive NCS S6010 G10Y	Bosque Forest NCS S7010-B90G	Blanco White
			
Teja Tile NCS S5030 Y90R	Roble natural Natural oak	Roble claro Light oak	Roble teñido wengue Wengue stained oak
			
Roble teñido ceniza Ash stained oak	Roble teñido tostado Toasted stained oak	Mármol blanco White marble	Mármol negro Black marble
			
Cerámica statuario Statuario ceramic	Cristal negro Black glass		

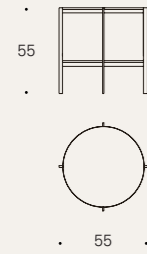

Top: Ø55 cm
Metal leg (1): 2,5 cm
Final size: Ø60 cm

EXO-55R **Ø55x55 cm** 0,241 m³ 15 Kg Mármol 23 Kg
Marble 23 Kg

- _____ Lacquer top / Micro-textured black thermo-lacquered structure
- _____ Oak top / Micro-textured black thermo-lacquered structure
- _____ Black glass top / Micro-textured black thermo-lacquered structure
- _____ Statuario ceramic top / Micro-textured black thermo-lacquered structure
- _____ Black or white marble top / Micro-textured black thermo-lacquered structure
- _____ Shelf finish: Lacquer
- _____ Option shelf finish: Oak*
- _____ Lacquer structure option*

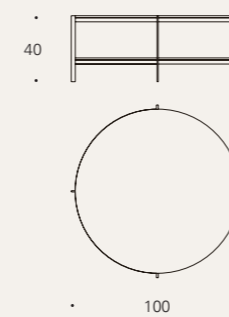

Top: Ø100 cm
Metal leg (1): 2,5 cm
Final size: Ø105 cm

EXO-04R **Ø100x40 cm** 0,610 m³ 38 Kg Mármol 77 Kg
Marble 77 Kg

- _____ Lacquer top / Micro-textured black thermo-lacquered structure
- _____ Oak top / Micro-textured black thermo-lacquered structure
- _____ Black glass top / Micro-textured black thermo-lacquered structure
- _____ Statuario ceramic top / Micro-textured black thermo-lacquered structure
- _____ Black or white marble top / Micro-textured black thermo-lacquered structure
- _____ Shelf finish: Lacquer
- _____ Option shelf finish: Oak*
- _____ Lacquer structure option*

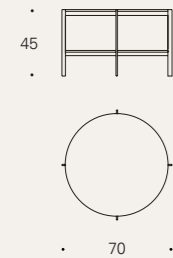

Top: Ø70 cm
Metal leg (1): 2,5 cm
Final size: Ø75 cm

EXO-74R **Ø70x45 cm** 0,346 m³ 21 Kg Mármol 41 Kg
Marble 41 Kg

- _____ Lacquer top / Micro-textured black thermo-lacquered structure
- _____ Oak top / Micro-textured black thermo-lacquered structure
- _____ Black glass top / Micro-textured black thermo-lacquered structure
- _____ Statuario ceramic top / Micro-textured black thermo-lacquered structure
- _____ Black or white marble top / Micro-textured black thermo-lacquered structure
- _____ Shelf finish: Lacquer
- _____ Option shelf finish: Oak*
- _____ Lacquer structure option*

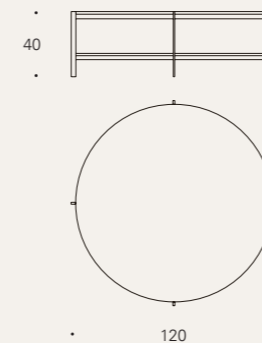

Top: Ø120 cm
Metal leg (1): 2,5 cm
Final size: Ø125 cm

EXO-24R **Ø120x40 cm** 0,858 m³ 52 Kg Mármol 105 Kg
Marble 105 Kg

- _____ Lacquer top / Micro-textured black thermo-lacquered structure
- _____ Oak top / Micro-textured black thermo-lacquered structure
- _____ Black glass top / Micro-textured black thermo-lacquered structure
- _____ Black or white marble top / Micro-textured black thermo-lacquered structure
- _____ Shelf finish: Lacquer
- _____ Option shelf finish: Oak*
- _____ Lacquer structure option*

