

Prices shown are not the final selling price.
To obtain the list price, multiply the price by 3.0.
Prices effective as September 2023.

ESSENS

design - Jonathan Prestwich



Designed by Jonathan Prestwich, the ESSENS tables combine versatility, beauty and harmonious proportions. The meeting point between two essential volumes in equilibrium generates a table base with a sculptural outline. The highly transversal ESSENS programme of tables comprises six types of 100% recyclable polyethylene table bases that allow composing tables in an endless variety of formats and sizes. The original design makes possible to configure tables with a single top or tables by sections of endless size. The bases have been designed to easily solve cable management. The tables can be equipped with different sockets, chargers, connections and accessories. The multiple possibilities of base and top combinations, together with the extensive range of available finishes, allows for endless customisation possibilities.

FINISHES

Rotomolded polyethylene colours

PE1 colours

standard colours

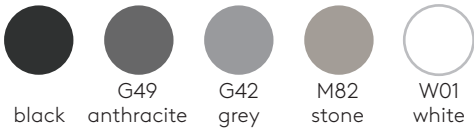

*B00 black 100% recycled material

PE2 colours

composed colours



PE3 colours

standard painted colours



*100% recycled material

PE4 colours

metallic painted colours



PE5 colours

bespoke painted colours

OPTIONALLY, the bases can be painted in all the colours of the RAL sample card, both in gloss and matt finish.

Tabletops

Lacquered MDF
22mm

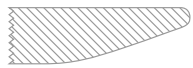

W1 colours



W2 colours

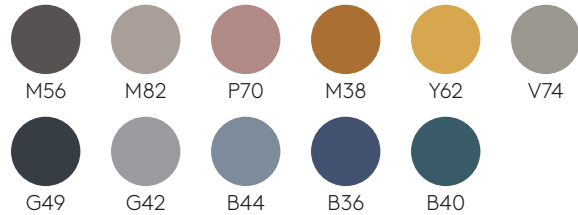

B00*
Oak & walnut veneer
23mm

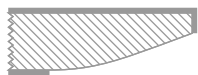

Oak



Walnut

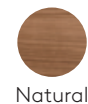

Solid HPL
12mm black core



Solid HPL
12mm white core



Solid FENIX®
12mm



CONFIGURATION GUIDE - TABLES WITH ROUND OR ELLIPTICAL BASES

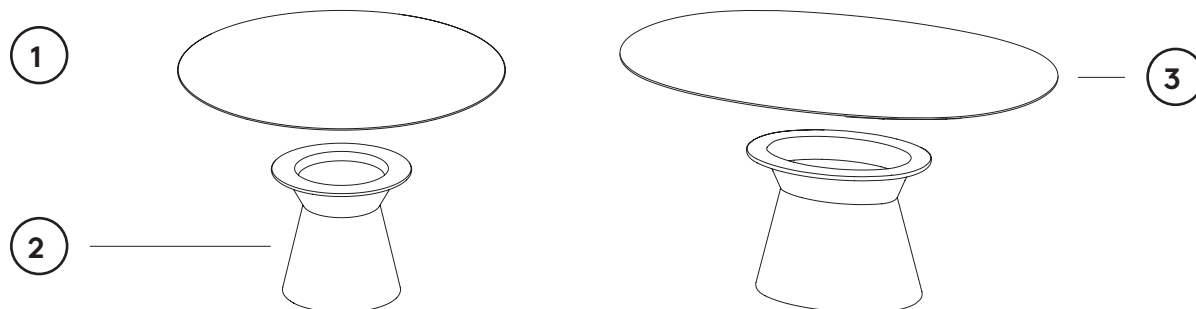

1 **SELECT THE BASE MODEL SUITABLE FOR YOUR TABLE**
The ESSENS collection offers bases in different sizes and formats. Choose the appropriate base for the size of the tabletop you need as indicated below next to each base.
Remark: the bases must be filled with the counterweight indicated for each one so that the table is stable. If you want to buy the counterweight from INCLASS, you must indicate in the order the code that appears in the price matrix of each base.

 Ø38cm H75	<p>TABLETOPS SIZES:</p> <p>Round tabletops: Ø60cm, Ø70cm, Ø80cm, Ø90cm and Ø100cm.</p> <p>Square tabletops: 60x60cm, 70x70cm, 80x80cm and 90x90cm.</p>
 Ø38cm H105	<p>TABLETOPS SIZES:</p> <p>Round tabletops: Ø60cm, Ø70cm, Ø80cm and Ø90cm.</p> <p>Square tabletops: 60x60cm, 70x70cm and 80x80cm.</p>
 Ø50cm H75	<p>TABLETOPS SIZES:</p> <p>Round tabletops: Ø120cm and Ø140cm.</p> <p>Square tabletops: 100x100cm and 120x120cm.</p>
 Ø65cm H75	<p>TABLETOPS SIZES:</p> <p>Round tabletops: Ø160cm, Ø180cm and Ø200cm.</p> <p>Square tabletops: 140x140cm and 160x160cm.</p>
 Elliptical base 95x63cm H75	<p>TABLETOP SIZE:</p> <p>Elliptical tabletops: 220x140cm, 240x140cm, 260x150cm and 280x150cm.</p>

2 **CHOOSE THE FINISH OF THE BASE**
The bases are available in the following finishes:

Colours PE1	Colours PE2	Colours PE3	Colours PE4	Colours PE5
-------------	-------------	-------------	-------------	-------------

The price matrix shows the price according to the different finishes.

3 **CHOOSE THE TABLETOP MATERIAL AND ITS FINISH**
The tabletops are available in the following materials:

Oak natural/stained	Walnut natural	Lacquered MDF colours W1	Lacquered MDF colours W2	Solid HPL 12mm*	Solid FENIX® 12mm*
------------------------	-------------------	-----------------------------	-----------------------------	--------------------	-----------------------

The price matrix shows the price according to the different sizes, materials and finishes.

+ **OPTIONAL ITEMS & ACCESSORIES** (page 11)
ESSENS tables can be ordered with different cable management and electrification accessories. If you need any, please indicate it in the order.

CONFIGURATION GUIDE - TABLES WITH OVAL BASES

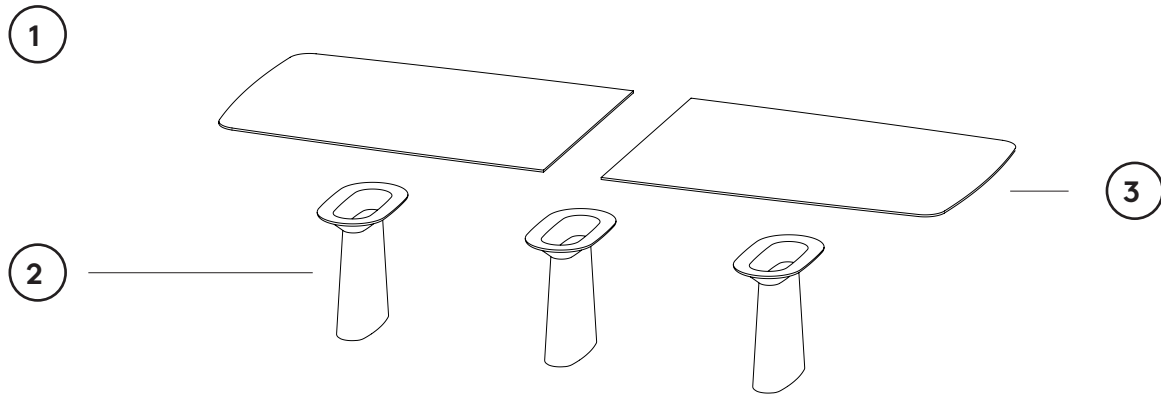

1 SELECT THE TABLE DIMENSIONS

The table with oval bases can be assembled with one piece tops or tops by sections.



TABLES WITH ONE PIECE TOP

Standard sizes: 200x100cm, 220x120cm, 240x120cm, 260x120cm, 280x140cm, and 300x140cm.
Two oval bases are needed for these tables.



TABLES WITH TWO END TOPS

Standard sizes: 400x140cm, 500x140cm and 600x140cm.
Three oval bases are needed for these tables.



TABLES WITH MULTIPLE TOP SECTIONS

They are configured with two end tabletops, available in sizes 250x140cm and 300x140cm and the desired intermediate tabletops by sections of 200x140cm.
An oval base is required for each end tabletop and for each joint of the intermediate sections.

Examples:

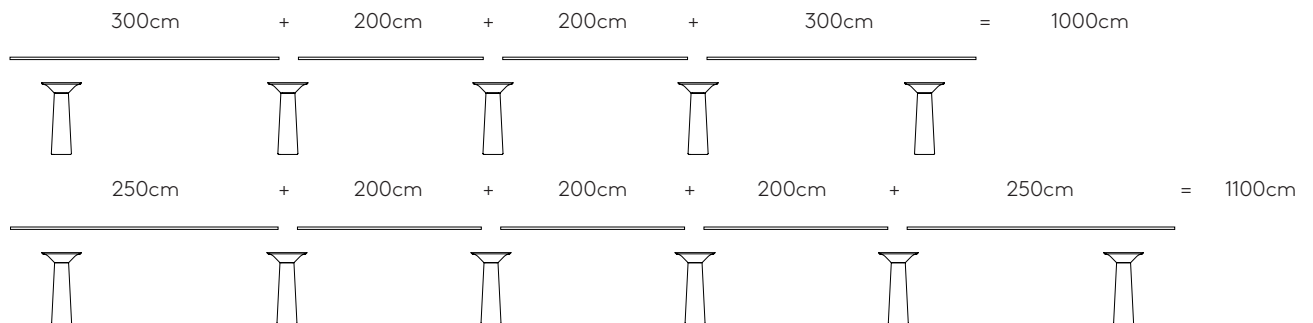

Remark:

- The oval base cannot be used as a single base, regardless of the measurements of the tabletop.
- The tabletops bigger than 260x120cm include reinforcement steel beams beneath the top.
- The bases must be filled with the counterweight indicated for each base so that the table is stable. If you want to buy it from INCLASS, you must indicate in the order the code that appears in the price matrix of each base.

2 CHOOSE THE FINISH OF THE BASE

The bases are available in the following finishes:

Colours PE1	Colours PE2	Colours PE3	Colours PE4	Colours PE5
-------------	-------------	-------------	-------------	-------------

The price matrix shows the price according to the different finishes.

3 CHOOSE THE TABLETOP MATERIAL AND ITS FINISH

The tabletops are available in the following materials:

Oak natural/stained	Walnut natural	Lacquered MDF colours W1	Lacquered MDF colours W2	Solid HPL 12mm*	Solid FENIX® 12mm*
------------------------	-------------------	-----------------------------	-----------------------------	--------------------	-----------------------

The price matrix shows the price according to the different sizes, materials and finishes.

+ OPTIONAL ITEMS & ACCESSORIES

ESSENS tables can be ordered with different cable management and electrification accessories. If you need any, please indicate it in the order.

Round base 38cm (top not included)



Round polyethylene table base Ø38cm. This base allows to build tables with round tops of up to Ø100cm and square tops of up to 90x90cm. The inner counterweight must be acquired separately.

For this base we recommend a minimum inner counter weight of 25kg.

Finishes: in colours PE1, PE2, PE3, PE4 and PE5 from our rothomolded polyethylene swatch card.

Code	Colours PE1 standard	Colours PE2 composed	Colours PE3 standard painted	Colours PE4 metallic painted	Colours PE5 special RAL colours
ES10010BA	270	285	532	555	612

Code	Optional items & accessories	€
ES30012OP	Counterweight 40kg of gravel	35
ES30020PS	Cable management tube for base	81

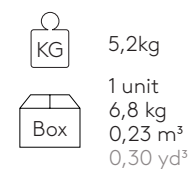
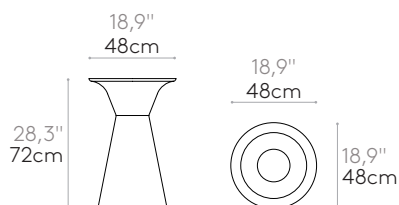

Round base 38cm stool height (top not included)

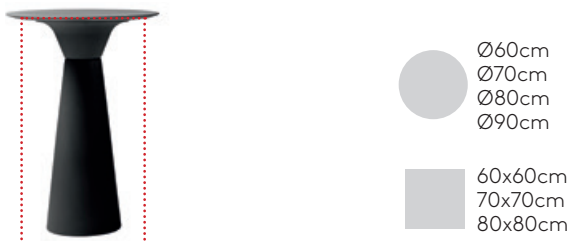

Round high polyethylene table base Ø38cm. This base allows to build tables with round tops of up to Ø90cm and square tops of up to 80x80cm. The inner counterweight must be acquired separately.

For this base we recommend a minimum inner counter weight of 25 kg.

Finishes: in colours PE1, PE2, PE3, PE4 and PE5 from our rothomolded polyethylene swatch card.

Code	Colours PE1 standard	Colours PE2 composed	Colours PE3 standard painted	Colours PE4 metallic painted	Colours PE5 special RAL colours
ES10040BA	334	352	661	691	759

Code	Optional items & accessories	€
ES30012OP	Counterweight 40kg of gravel	35
ES30024PS	Cable management tube for base	86

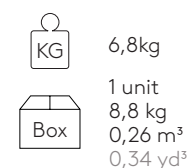
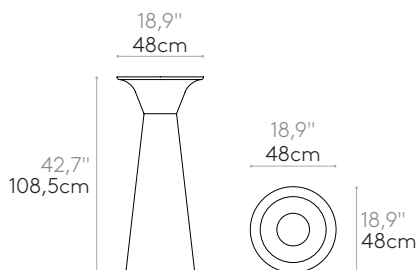

Round tabletops (for round base 38cm)



Tabletops for tables with round bases 38cm.
The prices indicated below are only for the tabletops.

Top size		60cm	70cm	80cm	90cm	100cm
Top material	Code	ES20060TP	ES20070TP	ES20080TP	ES20090TP	ES20100TP
Oak natural/stained		190	222	259	307	376
Walnut natural/stained		228	264	311	370	439
Lacquered MDF colours W1		152	178	215	259	324
Lacquered MDF colours W2		167	196	237	285	356
Solid HPL 12mm* black core		200	233	268	308	363
Solid HPL 12mm* white core		396	470	534	622	784
Solid FENIX® 12mm*		423	502	570	665	838

Square tabletops (for round base 38cm)

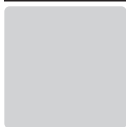

Tabletops for tables with round bases 38cm.
The prices indicated below are only for the tabletops.

Finishes book [+info](#)

Top size		60x60cm	70x70cm	80x80cm	90x90cm
Top material	Code	ES20606TP	ES20707TP	ES20808TP	ES20909TP
Oak natural/stained		218	256	308	356
Walnut natural/stained		255	298	361	418
Lacquered MDF colours W1		194	203	268	305
Lacquered MDF colours W2		213	223	295	336
Solid HPL 12mm* black core		202	237	274	313
Solid HPL 12mm* white core		398	477	537	626
Solid FENIX® 12mm*		425	511	573	669

* The size of the HPL tops may have variations of ±1cm.

Round base 50cm (top not included)



Round polyethylene table base Ø50cm. This base allows to build tables with round tops of up to Ø140cm and square tops of up to 120x120cm. The inner counterweight must be acquired separately.

For this base we recommend a minimum inner counter weight of 50kg.

Finishes: in colours PE1, PE2, PE3, PE4 and PE5 from our rothomolded polyethylene swatch card.

Code	Colours PE1 standard	Colours PE2 composed	Colours PE3 standard painted	Colours PE4 metallic painted	Colours PE5 special RAL colours
ES10020BA	354	370	669	701	771

Code	Optional items & accessories	€
ES30013OP	Counterweight 60kg of gravel	53
ES30022PS	Cable management tube for base	81

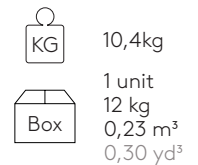
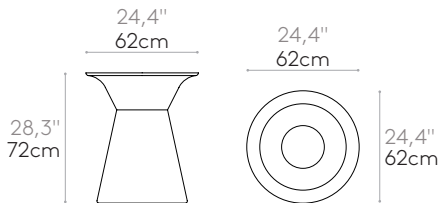

Round tabletops (for round base 50cm)



	Top size	120cm	140cm
Top material	Code	ES20120TP	ES20140TP
Oak natural/stained		516	679
Walnut natural/stained		582	768
Lacquered MDF colours W1		452	618
Lacquered MDF colours W2		497	680
Solid HPL 12mm* black core		554	644
Solid HPL 12mm* white core		951	1.332
Solid FENIX® 12mm*		1.015	1.423

Square tabletops (for round base 50cm)



	100x100cm	120x120cm	
Top material	Code	ES21010TP	ES21212TP
Oak natural/stained		450	595
Walnut natural/stained		490	633
Lacquered MDF colours W1		397	539
Lacquered MDF colours W2		437	593
Solid HPL 12mm* black core		357	569
Solid HPL 12mm* white core		788	946
Solid FENIX® 12mm*		842	1.011

Round base 65cm (top not included)



Round polyethylene table base Ø65cm. This base allows to build tables with round tops of up to Ø200cm and square tops of up to 160x160cm. The inner counterweight must be acquired separately.

For this base we recommend a minimum inner counter weight of 75kg.

Finishes: in colours PE1, PE2, PE3, PE4 and PE5 from our rothomolded polyethylene swatch card.

Code	Colours PE1 standard	Colours PE2 composed	Colours PE3 standard painted	Colours PE4 metallic painted	Colours PE5 special RAL colours
ES10050BA	584	607	983	1.019	1.141

Code	Optional items & accessories	€
ES30017OP	Counterweight 80kg of gravel	71
ES30023PS	Cable management tube for base	81

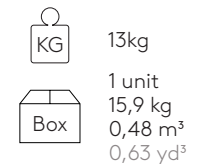
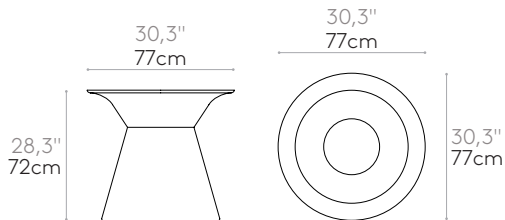

Round tabletops (for round base 65cm)



	Top size	160cm	180cm	200cm
Top material	Code	ES20160TP	ES20180TP	ES20200TP
Oak natural/stained		1.044	1.382	1.916
Walnut natural/stained		1.483	1.511	2.090
Lacquered MDF colours W1		760	1.006	1.572
Lacquered MDF colours W2		836	1.107	1.729
Solid HPL 12mm* black core		971	—	—
Solid HPL 12mm* white core		—	—	—
Solid FENIX® 12mm*		1.711	—	—

Square tabletops (for round base 65cm)



	140x140cm	160x160cm
Top material	Code	ES21616TP
		ES21414TP
		ES21616TP

	140x140cm	160x160cm
	789	11.78
	840	1.247
	697	905
	767	996
	666	941
	1.327	1.571
	1.418	1.679

Finishes book [+info](#)

Elliptical base (top not included)



220x140cm
240x140cm
260x150cm
280x150cm

Elliptical polyethylene table base. This base allows to build tables with elliptical tops of up to 280x150cm. The inner counterweight must be acquired separately.

For this base we recommend a minimum inner counter weight of 125kg.

Finishes: in colours PE1, PE2, PE3, PE4 and PE5 from our rothomolded polyethylene swatch card.

Code	Colours PE1 standard	Colours PE2 composed	Colours PE3 standard painted	Colours PE4 metallic painted	Colours PE5 special RAL colours
ES10060BA	667	706	1.200	1.244	1.394

Code	Optional items & accessories	€
ES30017OP	Counterweight 100kg of gravel (for tabletop: 220x140cm)	88
ES30019OP	Counterweight 120kg of gravel (for tabletops: 240x140cm, 260x150cm and 280x150cm)	106
ES30027PS	Cable management tube for base	81

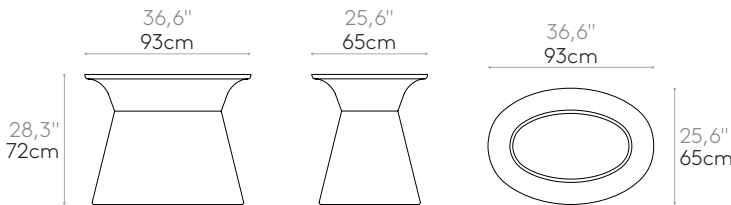

KG 19,5 kg
Box 1 unit
21,8 kg
0,39 m³
0,50 yd³

Elliptical tabletops (for elliptical bases)



Tabletops for tables with elliptical bases.

The prices indicated below are only for the tabletops.

	Top size	220x140cm	240x140cm**	260x150cm**	280x150cm**
Top material	Code	ES22214TE	ES22414TE	ES22615TE	ES22815TE
Oak natural/stained		1.582	2.049	2.280	2.473
Walnut natural/stained		1.823	2.269	2.548	2.684
Lacquered MDF colours W1		1.370	1.817	2.125	2.270
Lacquered MDF colours W2		1.507	1.999	2.338	2.497
Solid HPL 12mm* black core		1.282	1.760	1.984	2.117
Solid HPL 12mm* white core		2.333	2.867	—	—
Solid FENIX® 12mm*		2.493	3.064	3.534	3.786

Oval base (top not included)



Oval polyethylene table base. Using multiple bases allows to build tables with a maximum width of 140cm and infinite length. The inner counterweight must be acquired separately.

For this base we recommend a minimum inner counter weight of 40kg.

Finishes: in colours PE1, PE2, PE3, PE4 and PE5 from our rothomolded polyethylene swatch card.

Code	Colours PE1 standard	Colours PE2 composed	Colours PE3 standard painted	Colours PE4 metallic painted	Colours PE5 special RAL colours
ES10030BA	328	344	634	670	736

Code	Optional items & accessories	€
ES30012OP	Counterweight 40kg of gravel	35
ES30026PS	Cable management tube for base	81



2 bases

With 2 bases: 200x100, 220x120, 240x120, 260x120, 280x140x 300x140cm



3 bases

With 3 bases: 400x140, 500x140, 600x140cm



4 bases

With 4 bases: 700x140, 800x140cm

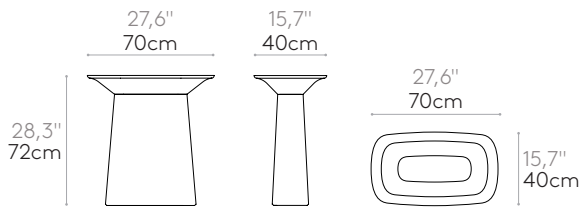

6,1kg



1 unit
7,8 kg
0,21 m³
0,28 yd³

Oval tabletops (for tables with 2 bases)



Tabletops for tables with 2 oval bases.

The prices indicated below are only for the tabletops.

Finishes book [+info](#)

Top size	200x100cm	220x120cm	240x120cm	260x120cm**	280x140cm**	300x140cm**	
Top material	Code	ES22010TP	ES22212TP	ES22412TP	ES22612TP	ES22814TP	ES23014TP
Oak natural/stained		1.161	1.406	1.525	1.943	2.270	2.351
Walnut natural/stained		1.297	1.574	1.708	2.225	2.526	2.718
Lacquered MDF colours W1		919	1.123	1.205	1.571	2.054	2.049
Lacquered MDF colours W2		1.011	1.235	1.326	1.728	2.259	2.254
Solid HPL 12mm* black core		934	1.217	1.325	1.714	2.005	2.042
Solid HPL 12mm* white core		1.693	1.886	2.180	2.674	3.223	3.621
Solid FENIX® 12mm*		1.809	2.014	2.330	2.856	3.442	3.870

Oval tabletops (for tables with 3 bases)





(for tables with 4 bases)





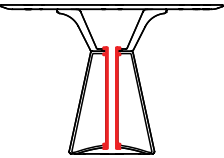

Top size	400x140cm**	500x140cm**	600x140cm**	700x140cm**	800x140cm**	
Top material	Code	ES24014TP	ES25014TP	ES26014TP	ES27014TP	ES28014TP
Oak natural/stained		3.415	4.198	4.905	5.925	6.583
Walnut natural/stained		3.633	4.475	5.163	6.321	7.019
Lacquered MDF colours W1		3.026	3.756	4.371	5.126	5.674
Lacquered MDF colours W2		3.329	4.132	4.808	5.639	6.241
Solid HPL 12mm* black core		2.835	3.546	4.202	4.882	5.492
Solid HPL 12mm* white core		4.733	5.919	7.205	8.209	9.501
Solid FENIX® 12mm*		5.056	6.323	7.698	8.769	10.150

* The size of the HPL tops may have variations of ±1cm.
** Includes reinforcement steel beams.

OPTIONAL ITEMS & ACCESSORIES

	Code	Description	€
	ES30012OP	40kg inner counterweight of gravel for table base	35
	ES30013OP	60kg inner counterweight of gravel for table base	53
	ES30015OP	80kg inner counterweight of gravel for table base	71
	ES30017OP	100kg inner counterweight of gravel for table base	88
	ES30019OP	120kg inner counterweight of gravel for table base	106
	ES30020PS	Cable management tube for base 38cm	81
	ES30022PS	Cable management tube for base 50cm	81
	ES30023PS	Cable management tube for base 65cm	81
	ES30024PS	Cable management tube for base 38cm stool height	86
	ES30026PS	Cable management tube for oval base	81
	ES30027PS	Cable management tube for elliptical base	81
		ES41212MA	Cut-out with lid for top access (12x12cm) *Cable tray not included *A drawing of the top with the exact position of cut-outs must be attached to the order.
	ES41224MA	Cut-out with lid for top access (24x12cm) *Cable tray not included *A drawing of the top with the exact position of cut-outs must be attached to the order.	151
	ES41236MA	Cut-out with lid for top access (36x12cm) *Cable tray not included *A drawing of the top with the exact position of cut-outs must be attached to the order.	155
	ES40120MA	Cut-out with lid for top access (Ø12cm) *Cable tray not included *A drawing of the top with the exact position of cut-outs must be attached to the order.	138
	ES40010ME	Custom cut-out on tabletop *A drawing of the top with the exact position of cut-outs must be attached to the order.	106
	ELC0060EL	Self adhesive cable holder mesh 30x40cm	37
	ELC0130	Under top cable tray L.30cm (Available inside Ø50cm, Ø65cm and elliptical bases. Also between bases in oval tables. Size: 140x80x300mm)	60
	ELC0140	Under top cable tray L.40cm (Available inside Ø65cm and elliptical bases. Also between bases in oval tables. Size: 140x80x400mm)	60
	ELC0180	Under top cable tray L.80cm (Available between bases in oval tables larger than 260cm. Size: 140x80x800mm)	87

OPTIONAL ITEMS & ACCESSORIES

	Code	Description	€
	ELC0010	<p>Plastic cable grommet with cover Ø80mm (Available in black or white)</p> <p>*A drawing of the top with the exact position of cut-outs must be attached to the order.</p>	30
	ELC0020EL	<p>Brushed aluminum grommet with cover Ø80mm</p> <p>*A drawing of the top with the exact position of cut-outs must be attached to the order.</p>	67
	ELC0030EL	<p>Wireless induction charger Ø80mm (Output: 2m cable Micro USB to USB)</p> <p>*A drawing of the top with the exact position of cut-outs must be attached to the order.</p>	217
	ELC0040EL	<p>USB charger with 2 ports Ø30mm (Output: 1,5m cable + Schucko transformer)</p> <p>*A drawing of the top with the exact position of cut-outs must be attached to the order.</p>	125