

Prices shown are not the final selling price.
To obtain the list price, multiply the price by 2.65.
Prices effective as June 2023.

METAL PEDESTALS



Mobile Pedestals - Standard



■ FEATURES

- 1 Steel sheet, 0,7 mm thickness
- 2 Electrostatic coat; thickness 90µm
- 3 Anti-footprints treatment
- 4 Antioxidant protection
- 5 Anti-tilt mechanism system
- 6 Single exterior frame without joints
- 7 Open-close position lock
- 8 Drawers and filing drawer with full extraction
- 9 Silent movements. Rubber runner-stop
- 10 Polyamide lateral locking bar
- 11 Anti-skid castors. Front castors lockable
- 12 5th castor for filing drawer to provide more stability and functionality
- 13 Pencil tray included
- 14 Optional dividers and metal adapter kit
- 15

Mobile Pedestals - Comfort



■ FEATURES

- 1 Steel sheet, 0,7 mm thickness
- 2 Electrostatic coat; thickness 90µm
- 3 Anti-footprints treatment
- 4 Antioxidant protection
- 5 Anti-tilt mechanism system
- 6 Single exterior frame without joints
- 7 Open-close position lock
- 8 Drawers and filing drawer with total extraction
- 9 Silent movements. Rubber runner-stop
- 10 Polyamide lateral locking bar
- 11 Anti-skid castors. Front castors lockable
- 12 5th castor for filing drawer to give more stability and functionality
- 13 Pencil tray included
- 14 Top cushion available in different finishes
- 15 Optional dividers and metal adapter kit

■ MODELS AND FINISHES

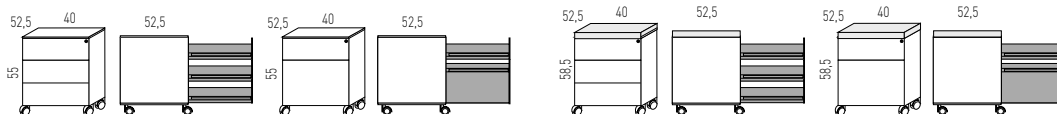

ALL METAL

ALL METAL WITH TOP CUSHION

ALL METAL - 1 COLOUR (0,7 mm) / ALL METAL - 2 COLOURS (0,7 mm)



Black

White

Silver

White / Black

FINISHES FOR PROJECTS

For projects that requires customization, contact our sales department.



Pistache

Orange

Blue







Grey

White Pistache

White Orange

White Blue

TABLE OF FINISHES

	WHITE	SILVER	BLACK	FABRIC GROUP T	FABRIC GROUP AE	FABRIC GROUP M
						
METAL	00	02	08			
FABRIC				T--	AE--	M--

For more details of colour finishes, go to the page of finishes. We recommend you check our physical samples, before delivery.

HOW TO ORDER A METAL PEDESTAL

To place an order for a product, the reference of the pedestal is supplemented with a code for upholstery, replacing the **2 RED dashes** with the desired color finish. The finishes available will be reflected in the corresponding price column.

Ex: **J632--** --> All white color --> **J632 00**

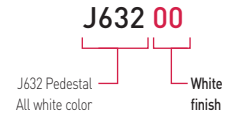

MOBILE METAL PEDESTALS - 40 cm WIDTH WITH TELESCOPIC RUNNERS. COMPLETE EXTRACTION OF THE DRAWER

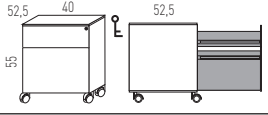
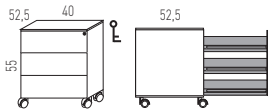
Models	Description	Structure	References	Finishes				Packaging Packs- Vol - Weight
				02 Silver	00 White	08 Black	08 Black	
J633 	<ul style="list-style-type: none"> 1 drawer with pencil tray 1 filing drawer Runners full extension With Lock Anti-tilt mechanism 	Metal One Color	J633--	375,20	375,20	375,20	16,25 Kg. Vol: 0,150 m ³ N° Packs: 1	
			White	J6330--				375,20
J632 	<ul style="list-style-type: none"> 3 drawers Pencil tray Runners full extension With Lock Anti-tilt mechanism 	Metal One Color	J632--	394,80	394,80	394,80	17,73 Kg. Vol: 0,150 m ³ N° Packs: 1	
			White	J6320--				394,80

MOBILE METAL PEDESTALS WITH TOP CUSHION - 40 cm WIDTH WITH TELESCOPIC RUNNERS. COMPLETE EXTRACTION OF THE DRAWER

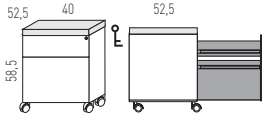
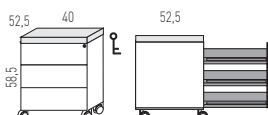
Models and sizes	Description	Structure	References	Finishes				Packaging Packs- Vol - Weight
				02 Silver	00 White	08 Black	08 Black	
JX633 	<ul style="list-style-type: none"> 1 drawer with pencil tray 1 filing drawer Runners full extension With Lock Anti-tilt mechanism 	Metal One Color	JX633--T--	408,80	408,80	408,80	16,50 Kg. Vol: 0,150 m ³ N° Packs: 1	
			JX633--AE--	420,00	420,00	420,00		
			JX633--M--	429,80	429,80	429,80		
			White	JX6330--T--				408,80
				JX6330--AE--				420,00
				JX6330--M--				429,80
JX632 	<ul style="list-style-type: none"> 3 drawers Pencil tray Runners full extension With Lock Anti-tilt mechanism 	Metal One Color	JX632--T--	435,40	435,40	435,40	18 Kg. Vol: 0,150 m ³ N° Packs: 1	
			JX632--AE--	446,60	446,60	446,60		
			JX632--M--	457,80	457,80	457,80		
			White	JX6320--T--				435,40
				JX6320--AE--				446,60
				JX6320--M--				457,80

Mobile Pedestals - Standard



■ FEATURES

- 1 Steel sheet, 0,7 mm thickness
- 2 Electrostatic coat; thickness 90µm
- 3 Anti-footprints treatment
- 4 Antioxidant protection
- 5 Anti-tilt mechanism system
- 6 Single exterior frame without joints
- 7 Open-close position lock
- 8 Drawers and filing drawer with total extraction
- 9 Silent movements. Rubber runner-stop
- 10 Polyamide lateral locking bar
- 11 Anti-skid castors. Front castors lockable
- 12 5th castor for filing drawer to give more stability and functionality
- 13 Pencil tray included
- 14 Optional dividers and metal adapter kit
- 15 MFC drawer fronts and top 16 mm in different finishes

■ MODELS AND FINISHES

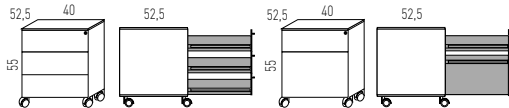

METAL FINISH (0,7 mm)



White

Silver

MFC FINISH (16 mm)



White

Lime Oak

Light Oak

Chestnut

Dark Oak

TABLE OF FINISHES

	WHITE	LIME OAK	LIGHT OAK	CHESTNUT	DARK OAK
					
MFC	00	11	10	07	14

For more details of colour finishes, go to the page of finishes. We recommend you check our physical samples, before delivery.

HOW TO ORDER A METAL PEDESTAL

To place an order for a product, the reference of the pedestal is supplemented with a code for upholstery, replacing the **2 RED dashes** with the desired color finish. The finishes available will be reflected in the corresponding price column.
Ex: **J6402--** --> Structure in white color / Front and Top in MFC white --> **J6420 00**

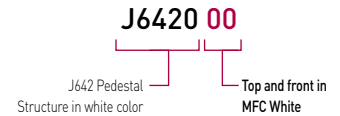

MOBILE METAL PEDESTALS WITH MFC TOP AND FRONT - 40 cm WIDTH WITH TELESCOPIC RUNNERS. COMPLETE EXTRACTION OF THE DRAWER

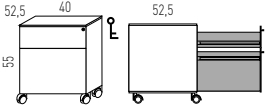
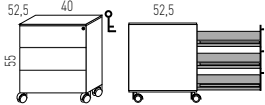
Models	Description	Structure	References	Top and Front MFC Finish	Packaging Packs - Vol - Weight
J643 	<ul style="list-style-type: none"> 1 drawer with pencil tray 1 filing drawer Runners full extension With Lock Anti-tilt mechanism 	White	J6430--	355,60	16,25 Kg. Vol: 0,150 m ³ Nº Packs: 1
		Silver	J6432--	355,60	
J642 	<ul style="list-style-type: none"> 3 drawers Pencil tray Runners full extension With Lock Anti-tilt mechanism 	White	J6420--	371,00	17,73 Kg. Vol: 0,150 m ³ Nº Packs: 1
		Silver	J6422--	371,00	

ACCESSORIES FOR 40cm WIDTH MOBILE PEDESTALS

Model and Sizes	Description	References	Black Steel	Packaging Packs - Vol - Weight
JX033 	Pack 10 units metal dividers for drawers. PACK 10 UNITS	JX033	54,60	2 Kg. Vol: 0,0078 m ³ Nº Packs: 1
JX031 	Pack 10 units metal dividers for Filing Drawer. PACK 10 UNITS	JX031	86,80	2 Kg. Vol: 0,0078 m ³ Nº Packs: 1
JX032 	Separating Rod for Holding Folders: FOOLSCAP, LETTER, FOLIO and LEGAL PACK 10 UNITS	JX032	33,60	0,5 Kg. Vol: 0,0145 m ³ Nº Packs: 1

FOR EXAMPLES OF MODULATIONS WITH THE USE OF RODS AND SEPARATORS IN FILING DRAWERS, GO TO PAGE 05



■ FEATURES

- 1 MFC top 16 mm thickness
- 2 Side panels 16 mm thickness
- 3 Anti-tilt mechanism system. Drawer blocked system for transport
- 4 Open-close position lock
- 5 Drawers and filing drawer with total extraction
- 6 Silent movements. Rubber runner-stop
- 7 Polyamide lateral locking bar
- 8 Standard castors.
- 9 5th castor for filing drawer to give more stability and functionality
- 10 Different combinations all in one colour or silver side panels with a colour
- 11 Optional pencil trays and dividers
- 12 Optional laminated security glass top PVB 5+5 mm thickness
- 13 Silver aluminium handles

■ MOBILE PEDESTALS PROGRAMME WITH TELESCOPIC RUNNERS. COMPLETE EXTRACTION OF THE DRAWER

- Accurate metal runners
- Monoblock plastic drawer with stationery tray (includes dividers)
- Models with filing drawer with a metal filing frame for A4 files
- Models with filing frame fo A4 and Folio

ALL DRAWERS

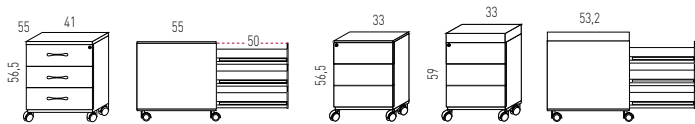

DRAWER + FILING DRAWER INCLUDING FRAME

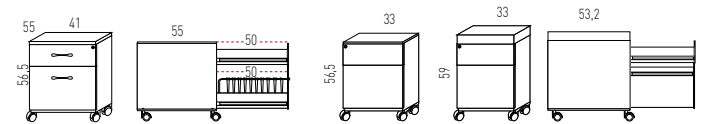

DRAWER + PULL OUT FILING FRAME

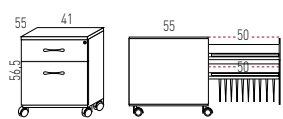

■ MOBILE PEDESTAL PROGRAMME WITH TELESCOPIC RUNNERS. DRAWER PARCIALLY OPENED.

- Simple metal runners with wheels
- Filing drawer with stationery tray
- Models with filing drawer with a metal filing frame for A4 files

ALL DRAWERS

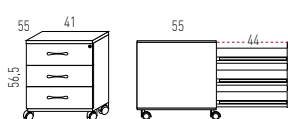

DRAWER + FILING DRAWER INCLUDING FRAME

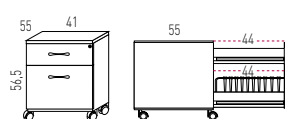

■ FINISHES (see finishes card)

MELAMINE (MFC) - 1 COLOUR

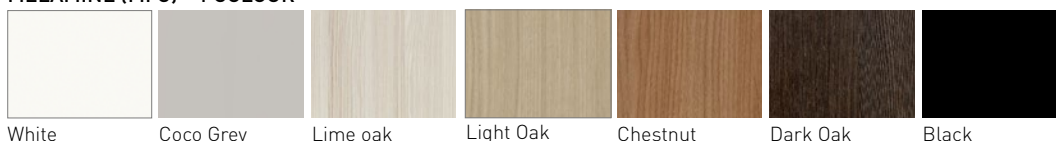

















MELAMINE (MFC) - 2 COLOURS



Aluminium Handle:
 - White MFC, Lime Oak or Coco Grey: White Handle.
 - White MFC / Lime oak: White Handle.
 - Rest of MFC finishes: Aluminium Handle

Prices shown are not the final selling price.
 To obtain the list price, multiply the price by 2.65.
 Prices effective as June 2023.

BUCKS - MFC							
1 COLOUR							
Carcass	White	Lime oak	Light Oak	Chestnut	Coco Grey	Dark Oak	Black
Handle	White	White	White	White	White	Black	Black
Picture							
2 COLOURS							
Carcass	White						
Front		Lime oak	Light Oak	Chestnut		Dark Oak	
Handle		White	White	White		Black	
Picture							
Carcass	Silver						
Front	White	Lime oak	Light Oak	Chestnut	Coco Grey		
Handle	White	Silver	Silver	Silver	Silver		
Picture							

FINISH CODE

To order a product, you will have to complete the reference with the finish code, replacing the two hyphens by the finish you need. Finishes available will be showed in the column price.

Example: J132-- White MFC top will be J13200

	WHITE	COCO GREY	LIGHT OAK	CHESTNUT	LIME OAK	DARK OAK	BLACK
MFC	00	15	10	07	11	14	03

MOBILE PEDESTALS WITH METAL RUNNERS WITH WHEELS

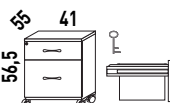
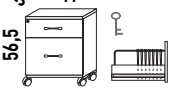
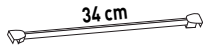
MODELS AND SIZES	DESCRIPTION	CARCASS FINISH	REFERENCES	TOP AND FRONT							PACKAGING Packs- Vol - Weight
				WHITE	COCO GREY	LIME OAK	LIGHT OAK	CHESTNUT	DARK OAK	BLACK	
J132 	<ul style="list-style-type: none"> · 3 drawers. · pencil trays and dividers · Lock. 	ALL ONE FINISH	J132--	274,40	274,40	274,40	274,40	274,40	274,40	316,40	Packs: 1 Vol: 0,1523 m ³ Weight: 19 Kg.
		SILVER	J1322--	274,40		274,40	274,40				
J133 	<ul style="list-style-type: none"> · 1 drawer. · 1 filing frame. · pencil trays and dividers · Lock. 	ALL ONE FINISH	J133--	281,40	281,40	281,40	281,40	281,40	281,40	323,40	Packs: 1 Vol: 0,1523 m ³ Weight: 18 Kg.
		SILVER	J1332--	281,40		281,40	281,40				
J140 	<ul style="list-style-type: none"> · 1 drawer. · 1 filing drawer. · pencil trays and dividers · Lock. 	ALL ONE FINISH	J140--	271,60	271,60	271,60	271,60	271,60	271,60	316,40	Packs: 1 Vol: 0,1523 m ³ Weight: 19 Kg.
		SILVER	J1402--	271,60		271,60	271,60				
JX10 	Metal adapter for legal, foolscap and letter suspension files	Kit 10 units	JX10							40,60	Packs: 1 Vol: 0,0025 m ³ Weight: 1 Kg.

MOBILE PEDESTALS WITH METAL RUNNERS WITH WHEELS

MODELS AND SIZES	DESCRIPTION	CARCASS FINISH	REFERENCES	WHITE	COCO GREY	LIME OAK	LIGHT OAK	CHESTNUT	DARK OAK	BLACK	PACKAGING Packs- Vol - Weight
J832 	<ul style="list-style-type: none"> · 3 drawers. · pencil trays and dividers · Lock. 	ALL ONE FINISH	J832--	228,20	228,20	228,20	228,20	228,20	228,20	267,40	Packs: 1 Vol: 0,1523 m ³ Weight: 17,5 Kg.
J840 	<ul style="list-style-type: none"> · 1 drawer. · 1 filing drawer. · pencil trays and dividers · Lock. 	ALL ONE FINISH	J840--	229,60	229,60	229,60	229,60	229,60	229,60	270,20	Packs: 1 Vol: 0,1523 m ³ Weight: 19 Kg.

MOBILE PEDESTAL WITH METAL RUNNERS

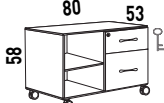
MODELS AND SIZES	DESCRIPTION	CARCASS FINISH	REFERENCES	WHITE	COCO GREY	LIME OAK	LIGHT OAK	CHESTNUT	BLACK	PACKAGING Packs- Vol - Weight
J90 	Mobile pedestal 80 x 53 x 58 cm including: <ul style="list-style-type: none"> · 1 height adjustable shelf · 1 lockable drawer · 1 filing drawer · 1 Divider and stationary tray 	ALL ONE FINISH	J90--	357,00	357,00	357,00	357,00	357,00	425,60	Packs: 1 Vol: 0,16583 m ³ Weight: 17,5 Kg.

MOBILE PEDESTALS WITH METAL DRAWER AND RUNNERS

MODELS AND SIZES	DESCRIPTION	CARCASS FINISH	REFERENCES	TOP AND FRONT							PACKAGING Packs- Vol - Weight
				WHITE	COCO GREY	LIME OAK	LIGHT OAK	CHESTNUT	DARK OAK	BLACK	
JM132 	<ul style="list-style-type: none"> · 3 drawers. · pencil trays and dividers · Lock. 	ALL ONE FINISH	JM132--	378,00	378,00	378,00	378,00	378,00	378,00	420,00	Packs: 1 Vol: 0,16583 m ³ Weight: 21 Kg.
		SILVER	JM1322--	378,00		378,00					
JM133 	<ul style="list-style-type: none"> · 1 drawer. · 1 filing drawer. · pencil trays and dividers · Lock. 	ALL ONE FINISH	JM133--	331,80	331,80	331,80	331,80	331,80	331,80	372,40	Packs: 1 Vol: 0,16583 m ³ Weight: 19 Kg.
		SILVER	JM1332--	331,80		331,80					

FINISH CODE

To order a product, you will have to complete the reference with the finish code, replacing the two hyphens by the finish you need. Finishes available will be showed in the column price.

Example: J132-- White MFC top will be J13200

	WHITE	COCO GREY	LIGHT OAK	CHESTNUT	LIME OAK	DARK OAK	BLACK
MFC	00	15	10	07	11	14	03

MOBILE PEDESTALS WITH METAL RUNNERS AND TOP CUSHION

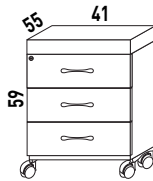

- Top cushion available in different finishes
- Reinforced frame
- 3 drawers
- Pencil tray and 3 BOOK STANDS FOR SHELVES
- Metal runners with plastic wheels
- Lock



- Top cushion available in different finishes
- Reinforced frame
- 1 drawer
- 1 filing frame
- Pencil tray and 3 BOOK STANDS FOR SHELVES
- Metal runners with plastic wheels
- Lock

How to order it: Please add to the reference of the pedestal required the fabric for the cushion.

Example: JX32-- all in white will be --> JX3200 + pistaccio cushion T81 --> will be: JX3200 T81

MODELS AND SIZES	DESCRIPTION	CARCASS FINISH	REFERENCES	TOP AND FRONT							PACKAGING Packs- Vol - Weight
				WHITE	COCO GREY	LIME OAK	LIGHT OAK	CHESTNUT	DARK OAK	BLACK	
JX32 	· 3 drawers. · Pencil tray and 3 BOOK STANDS FOR SHELVES. · Lock. · Top cushion.	ALL ONE FINISH	JX32--T--	358,40	358,40	358,40	358,40	358,40	358,40	400,40	Packs: 1 Vol: 0,14583 m ³ Weight: 21 Kg.
			JX32--AE--	366,80	366,80	366,80	366,80	366,80	366,80	366,80	
			JX32--M--	373,80	373,80	373,80	373,80	373,80	373,80	415,80	
		SILVER	JX322--T--	358,40	358,40	358,40	358,40				
			JX322--AE--	366,80	366,80	366,80	366,80				
			JX322--M--	373,80	373,80	373,80	373,80				
JX33 	· 1 drawer. · 1 filing drawer. · Pencil tray and 3 BOOK STANDS FOR SHELVES. · Lock. · Top cushion.	ALL ONE FINISH	JX33--T--	372,40	372,40	372,40	372,40	372,40	372,40	414,40	Packs: 1 Vol: 0,14583 m ³ Weight: 19 Kg.
			JX33--AE--	380,80	380,80	380,80	380,80	380,80	380,80	380,80	
			JX33--M--	389,20	389,20	389,20	389,20	389,20	389,20	431,20	
		SILVER	JX332--T--	372,40	372,40	372,40	372,40				
			JX332--AE--	380,80	380,80	380,80	380,80				
			JX332--M--	389,20	389,20	389,20	389,20				

FINISH CODE

To order a product, you will have to complete the reference with the finish code, replacing the two hyphens by the finish you need. Finishes available will be showed in the column price.

Example: J164-- White MFC top will be J16400

	WHITE	COCO GREY	LIGHT OAK	CHESTNUT	LIME OAK	DARK OAK	BLACK
MFC	00	15	10	07	11	14	03

DESK HEIGHT PEDESTALS WITH METAL RUNNERS

MODELS AND SIZES	CARCASS FINISH	REFERENCES	MFC TOP AND FRONT							PACKAGING Packs- Vol - Weight
			WHITE	COCO GREY	LIME OAK	LIGHT OAK	CHESTNUT	DARK OAK	BLACK	
J164 <ul style="list-style-type: none"> Desk Height 2 drawers. pencil trays and dividers 1 filing frame Lock. 	ALL ONE FINISH	J164--	369,60	369,60	369,60	369,60	369,60	369,60	414,40	Packs: 1 Vol: 0,1523 m ³ Weight: 19 Kg.
	SILVER	J1642--	369,60				369,60			
J184 <ul style="list-style-type: none"> Desk Height 2 drawers. pencil trays and dividers 1 filing drawer. Lock. 	ALL ONE FINISH	J184--	348,60	348,60	348,60	348,60	348,60	348,60	394,80	Packs: 1 Vol: 0,1523 m ³ Weight: 18 Kg.
	SILVER	J1842--	348,60				348,60			
J166 <ul style="list-style-type: none"> Desk Height 4 drawers. pencil trays and dividers Lock. 	ALL ONE FINISH	J166--	358,40	358,40	358,40	358,40	358,40	358,40	404,60	Packs: 1 Vol: 0,1523 m ³ Weight: 19 Kg.
	SILVER	J1662--	358,40				358,40			
J165 <ul style="list-style-type: none"> Desk Height 2 drawers. pencil trays and dividers 1 filing frame. Lock. 	ALL ONE FINISH	J165--	401,80	401,80	401,80	401,80	401,80	401,80	463,40	Packs: 1 Vol: 0,1523 m ³ Weight: 19 Kg.
	SILVER	J1652--	401,80				401,80			
J167 <ul style="list-style-type: none"> Desk Height 4 drawers. pencil trays and dividers Lock. 	ALL ONE FINISH	J167--	389,20	389,20	389,20	389,20	389,20	389,20	449,40	Packs: 1 Vol: 0,1523 m ³ Weight: 19 Kg.
	SILVER	J1672--	389,20				389,20			

HANDLES FOR STORAGES AND BUCK WITH MFC DOORS

	FINISHED	PACK UNITS	REFERENCE	P.V.P UNIT
	WHITE	4 UNITS	JPT10B	18,20
	SILVER	4 UNITS	JPT10	18,20
	BLACK	4 UNITS	JPT10N	18,20

STORAGE UNITS



- ① Sliding door
- ② Integrated runner system, Surface totally usable Embossed handles
- ③ Height adjustable shelves each 32 mm
- ④ Fitted handles by injected aluminium
- ⑤ Drawers with total extraction
- ⑥ Cable access \varnothing 58 cm

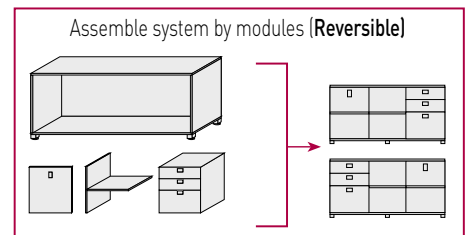

■ STORAGE UNITS

· 2 sliding doors

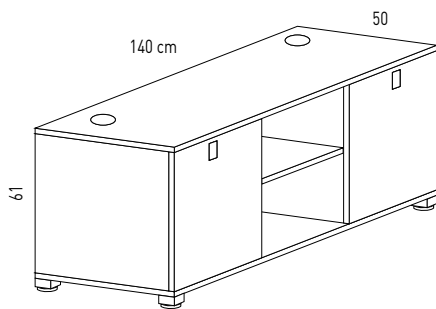

· Drawers/Door

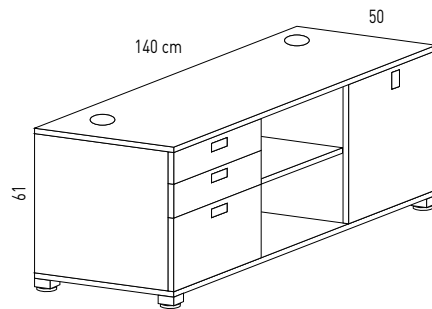

■ HUTCH IN OPTION

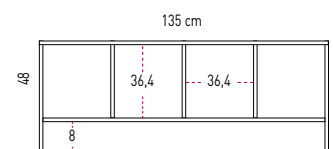
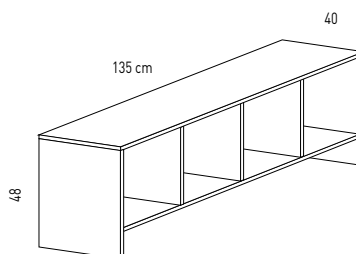

■ STORAGE UNITS

MFC frame composed by reversible modular system with shelves, sliding doors and or drawers and filing drawers. Two different models:

· Model with shelves and sliding doors

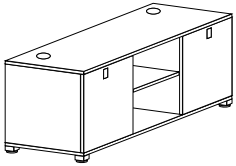

- 1 Top and base, 25 mm thickness
- 2 Inner side panels, mfc 19 mm thickness. Back panel 16 mm thickness
- 3 Shelves are manufactured by mfc 16 mm thickness. Height adjustable every 32 mm
- 4 Ergonomic handles produced with Zamak, aluminium alloy.
- 5 Levelers supports, inner easy access +20 mm
- 6 Anti skid PVC cap included in the levellers
- 7 2 cable access Ø80 mm, PVC top cover
- 8 MFC sliding door 16 mm thickness
- 9 Thermoplastic runner inserted in the base. Plane base without any obstacle

· Model with shelves and sliding doors

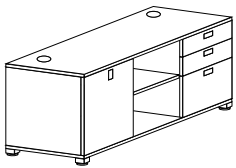
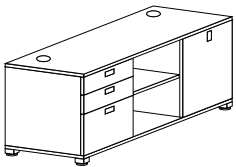

- 1 Top and base, 25 mm thickness
- 2 Inner side panels, MFC 19 mm thickness. Back panel 16 mm thickness
- 3 Shelves are manufactured by mfc 16 mm thickness. Height adjustable every 32 mm
- 4 Ergonomic handles produced with Zamak, aluminium alloy.
- 5 **Drawers:** Top security lock. Two positions, open and close. An unique key.
- 6 Levelers supports, inner easy access +20 mm
- 7 Anti skid PVC cap included in the levellers
- 8 2 cable access Ø80 mm, PVC top cover
- 9 Drawers and filing frames with MFC front panel 16 mm thickness
- 10 Drawers and filing frames with telescopic steel runners totally opened
- 11 Anti tilt mechanism (avoiding to open all drawers at the same time)

· Optional hutches for desk-support credenza units.

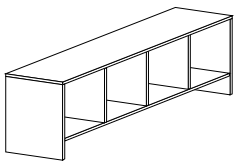

- 1 Optional hutch manufactured by MFC 19 mm thickness. Inner space 36,4 x 36,4 cm

■ FINISHES

MFC

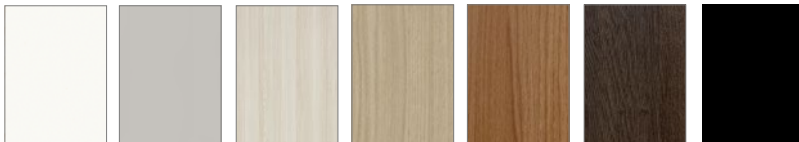

White Coco Grey Lime Oak Light Oak Chestnut Dark Oak Black

(see finishes card)



Aluminium Handle:

- **White MFC or Lime Oak:** White Handle.
- **Rest of MFC finishes:** Aluminium Handle

FINISH CODE FOR TOP

To order a product, you will have to complete the reference with the **top finish** replacing the two hyphens by the finish you need. Finishes available will be showed in the column price.
Example: HPL91412--Y WHITE MFC will be --> HPL9141200Y

	WHITE	GRIS COCO	LIME OAK	LIGHT OAK	CHESTNUT	DARK OAK	BLACK
MFC	00	15	11	10	07	14	03

DESK-SUPPORT CREDENZA UNIT

TECHNICAL FEATURES

- MFC structure. Different finishes.
- 2 Cable access.
- 2 models:

 - Shelves and sliding doors
 - Shelves, drawers/filing drawer and sliding door (reversible modules)

- Feet with levelers

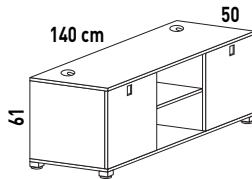

AB101 Storage with sliding doors and shelves

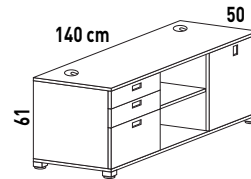

AB102 Storage with sliding doors, shelves, drawers and filing drawers (reversible modules).

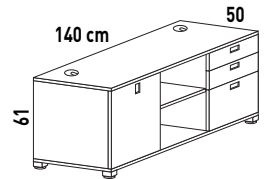

MODELS AND SIZES	LEGS	REFERENCES	MFC	PACKAGING (Packs- Vol - Weight)
<p>AB101</p>	Levelers	AB101--	523,60	673,40 Packs: 1 Vol: 0,18 m ³ Weight: MFC: 55 Kg.
<p>AB102</p> <p>Reversible inner modules</p>	Levelers	AB102--	809,20	959,00 Packs: 1 Vol: 0,18 m ³ Weight: MFC: 55 Kg.

HUTCH FOR DESK-SUPPORT CREDENZA UNIT

MODELS AND SIZES	TECHNICAL FEATURES	REFERENCES	MFC	PACKAGING (Packs- Vol - Weight)
<p>AB901</p>	Hutch for desk-support filing unit MFC 19mm. Different choices.	AB901--	204,40	249,20 Packs: 1 Vol: 0,1 m ³ Weight: MFC: 16,5 Kg.

FINISH CODE

To order a product, you will have to complete the reference with the **finish code**, replacing the two hyphens by the finish you need. Finishes available will be showed in the column price.
Example: AL288-- White MFC pedestal will be AL28800

	WHITE	COCO GREY	LIME OAK	LIGHT OAK	CHESTNUT	DARK OAK	BLACK
MFC	00	15	11	10	07	14	03

HUTCHES FOR DESKS / PEDESTALS 80 cm WIDTH



Hutches allows us to get a side filing space on the desk top or pedestal. In COOL, VITAL and VITAL PLUS , they can divide workplaces. With this system we reduce cost as we do not use progressive legs or divided screens.

MODELS AND SIZES	STRUCTURE	REFERENCES	WHITE	COCO GREY	LIME OAK	LIGHT OAK	DARK OAK	CHESTNUT	BLACK	PACKAGING Packs- Vol - Weight
<p>AL200</p>	ALL ONE FINISH	AL200--	151,20	151,20	151,20	151,20	151,20	151,20	191,80	Packs: 1 Vol: 0,01523 m ³ Weight: 17,5 Kg.