

## Kotai. Mario Ruiz, 2015/2021

[Structure made of solid wood profile from European oaks. Tabletop made of solid wood from European oaks with 21 mm/0.83" of section. Also available in European oak veneer. Delivered unassembled.

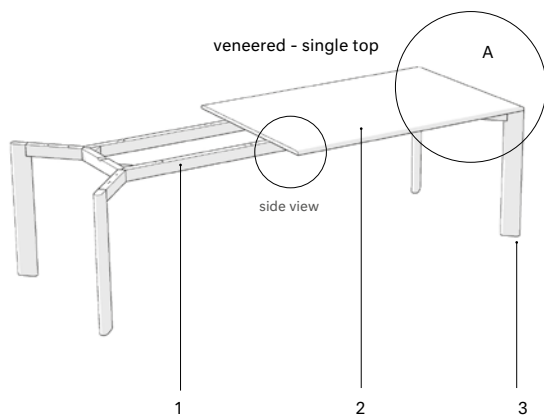

- 1 Structure made of solid wood profile from European oaks.
- 2 Tabletop options:
  - single veneered top 21 mm/0.83" thick.
  - 2 slats solid wood top 21 mm/0.83" thick.
- 3 Injected PA spacers.

Tabletop options:

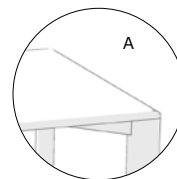

- single veneered top  
21 mm/0.83" thick.

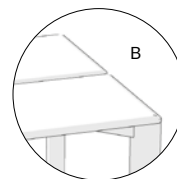



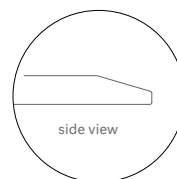



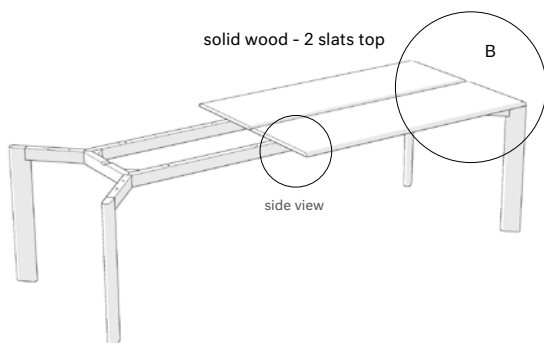























- 2 slats solid wood top  
21 mm/0.83" thick.











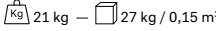

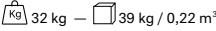

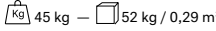

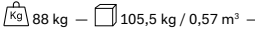
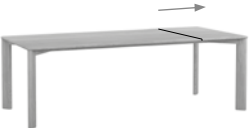
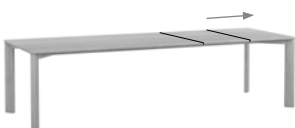





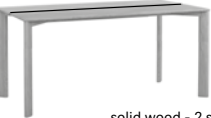

- 21 mm/0.83" thick.











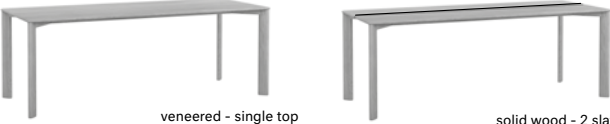



Ref.	Article	Total (CAD\$)	
		veneered top	solid wood
T457 180	<b>Rectangular dining table</b>		
		<p>OPTIONS</p> <div style="display: flex; justify-content: space-around;"> <div style="text-align: center;">  <p>veneered - single top</p> </div> <div style="text-align: center;">  <p>solid wood - 2 slats top</p> </div> </div> <p>180x100x75 70.75" x 39.25" x 29.5"</p> <p> 44 kg —  52 kg / 0,27 m<sup>3</sup></p>	single top
		\$7,583	\$8,907
T457 200	<b>Rectangular dining table</b>		
		<p>OPTIONS</p> <div style="display: flex; justify-content: space-around;"> <div style="text-align: center;">  <p>veneered - single top</p> </div> <div style="text-align: center;">  <p>solid wood - 2 slats top</p> </div> </div> <p>200x100x75 78.75" x 39.25" x 29.5"</p> <p> 49 kg —  57 kg / 0,30 m<sup>3</sup></p>	single top
		\$8,168	\$9,339
T457 220	<b>Rectangular dining table</b>		
		<p>OPTIONS</p> <div style="display: flex; justify-content: space-around;"> <div style="text-align: center;">  <p>veneered - single top</p> </div> <div style="text-align: center;">  <p>solid wood - 2 slats top</p> </div> </div> <p>220x100x75 86.5" x 39.25" x 29.5"</p> <p> 54 kg —  62 kg / 0,33 m<sup>3</sup></p>	single top
		\$8,646	\$9,686
T457 240	<b>Rectangular dining table</b>		
		<p>OPTIONS</p> <div style="display: flex; justify-content: space-around;"> <div style="text-align: center;">  <p>veneered - single top</p> </div> <div style="text-align: center;">  <p>solid wood - 2 slats top</p> </div> </div> <p>240x100x75 94.5" x 39.25" x 29.5"</p> <p> 59 kg —  67 kg / 0,36 m<sup>3</sup></p>	single top
		\$9,306	\$10,808

Ref.	Article	Total (CAD\$)	
		veneered top	solid wood
<b>T457 260</b>	<b>Rectangular dining table</b>		
	OPTIONS	single top	2 slats top
	 veneered - single top	\$9,517	\$10,923
	 solid wood - 2 slats top		
	260x100x75 102.25" x 39.25" x 29.5"		
		 64 kg	 72 kg / 0,38 m <sup>3</sup>
<b>T456 100</b>	<b>Square dining table</b>		
	 single top	single top	single top
	100x100x75 39.25" x 39.25" x 29.5"	\$5,594	\$6,887
		 27 kg	 33 kg / 0,15 m <sup>3</sup>
<b>T456 120</b>	<b>Square dining table</b>		
	 single top	single top	single top
	120x120x75 47.25" x 47.25" x 29.5"	\$6,138	\$7,715
		 40 kg	 46 kg / 0,22 m <sup>3</sup>
<b>T456 140</b>	<b>Square dining table</b>		
	 veneered - single top	single top	2 slats top
	 solid wood - 2 slats top	\$7,772	\$9,646
	140x140x75 55" x 55" x 29.5"		
		 52 kg	 59 kg / 0,29 m <sup>3</sup>

Ref.	Article	Total (CAD\$)	
		veneered top	solid wood
<b>T455 100</b>	<b>Round dining table</b>		
	 single top Ø100x75 Ø 39.25" x 29.5"	single top	single top
		\$5,188	\$6,481
		 21 kg — 27 kg / 0,15 m <sup>3</sup>	
<b>T455 120</b>	<b>Round dining table</b>		
	 single top Ø120x75 Ø 47.25" x 29.5"	single top	single top
		\$6,089	\$7,666
		 32 kg — 39 kg / 0,22 m <sup>3</sup>	
<b>T455 140</b>	<b>Round dining table</b>		
	OPTIONS  veneered - single top Ø140x75 Ø 55" x 29.5"	single top	2 slats top
	 solid wood - 2 slats top		
		\$7,706	\$9,564
		 45 kg — 52 kg / 0,29 m <sup>3</sup>	
<b>T460</b>	<b>Rectangular expandable dining table</b>		
	 single top 190x100x75 74.75" x 39.25" x 29.5"	single top	
		\$11,890	
		 88 kg — 105,5 kg / 0,57 m <sup>3</sup> —	
	 240x100x75 94.5" x 39.25" x 29.5"		
	 290x100x75 114.25" x 39.25" x 29.5"		

Ref.	Article	Total (CAD\$)	
		veneered top	solid wood
T477 180	<b>Rectangular high dining table</b>	OPTIONS	
		single top	2 slats top
	  <p>veneered - single top      solid wood - 2 slats top</p> <p>180x100x90 70.75" x 39.25" x 35.5"</p> <p> 47 kg —  55 kg / 0,27 m<sup>3</sup></p>	\$8,319	\$9,643
T477 200	<b>Rectangular high dining table</b>	OPTIONS	
		single top	2 slats top
	  <p>veneered - single top      solid wood - 2 slats top</p> <p>200x100x90 78.75" x 39.25" x 35.5"</p> <p> 52 kg —  60 kg / 0,30 m<sup>3</sup></p>	\$8,903	\$10,075
T477 220	<b>Rectangular high dining table</b>	OPTIONS	
		single top	2 slats top
	  <p>veneered - single top      solid wood - 2 slats top</p> <p>220x100x90 86.5" x 39.25" x 35.5"</p> <p> 57 kg —  65 kg / 0,33 m<sup>3</sup></p>	\$9,382	\$10,421
T477 240	<b>Rectangular high dining table</b>	OPTIONS	
		single top	2 slats top
	  <p>veneered - single top      solid wood - 2 slats top</p> <p>240x100x90 94.5" x 39.25" x 35.5"</p> <p> 62 kg —  70 kg / 0,36 m<sup>3</sup></p>	\$10,042	\$11,543

Ref.	Article	Total (CAD\$)	
		veneered top	solid wood
<b>T477 260</b>	<b>Rectangular high dining table</b>		
	OPTIONS	single top	2 slats top
	 <p>veneered - single top      solid wood - 2 slats top</p> <p>260x100x90 102.25" x 39.25" x 35.5"</p> <p> 67 kg —  75 kg / 0,38 m<sup>3</sup></p>	\$10,253	\$11,659
<b>T480 120</b>	<b>Desk</b>	single top	single top
	 <p>single top</p> <p>120x50x75 47.25" x 19.75" x 29.5"</p> <p> 25 kg —  29 kg / 0,15 m<sup>3</sup></p>	\$4,617	\$4,910
<b>T480 150</b>	<b>Desk</b>	single top	single top
	 <p>single top</p> <p>150x50x75 59" x 19.75" x 29.5"</p> <p> 29 kg —  33 kg / 0,18 m<sup>3</sup></p>	\$5,148	\$5,442
<b>T480 180</b>	<b>Desk</b>	single top	single top
	 <p>single top</p> <p>180x50x75 70.75" x 19.75" x 29.5"</p> <p> 33 kg —  37 kg / 0,22 m<sup>3</sup></p>	\$5,759	\$5,983