

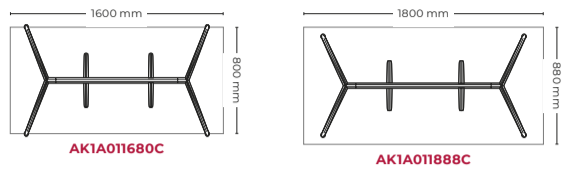
Prices shown are not the final selling price.  
To obtain the list price, multiply the price by 2.65.  
Prices effective as February 2024.

# ARKITEK

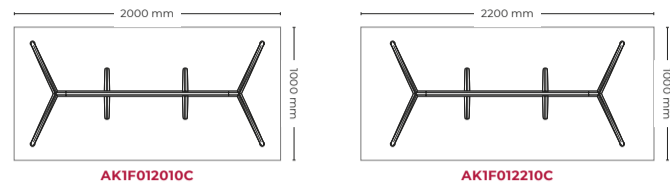


Table program

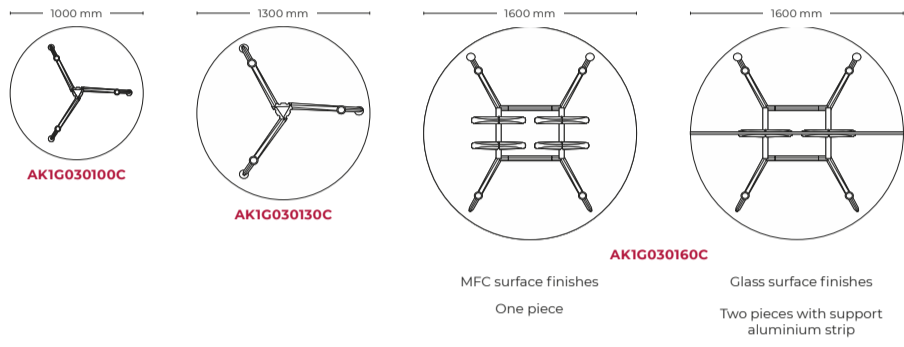
Individual operating tables and management · Width 800 / 880 mm



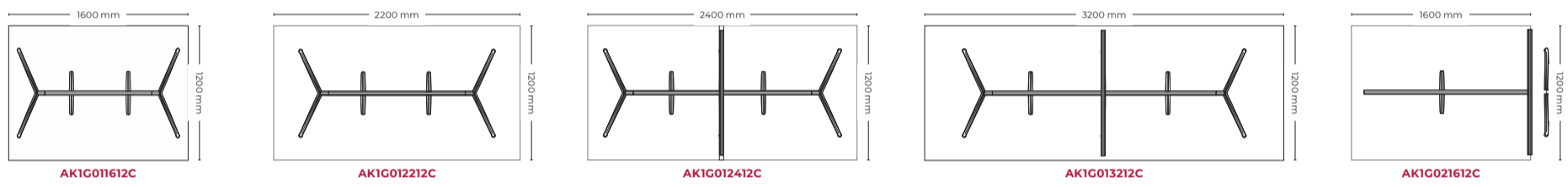
Management desks · Width 1000 mm



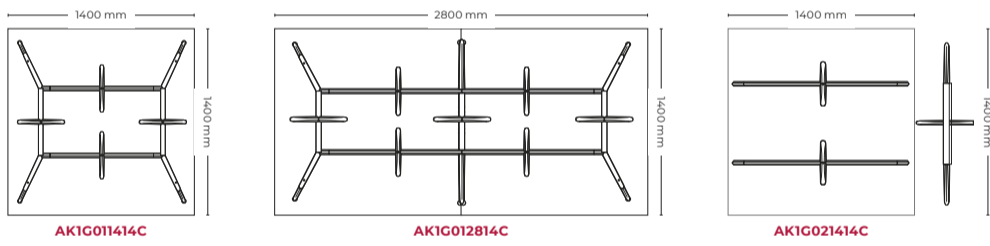
Meeting tables · Circular



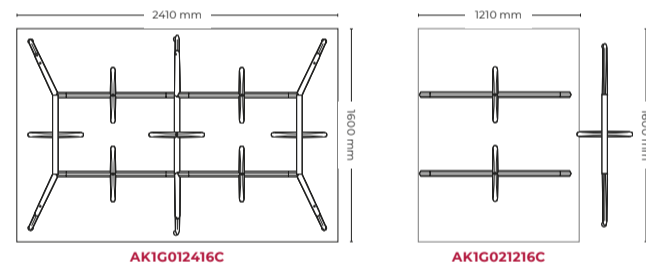
Meeting tables · Width 1200 mm



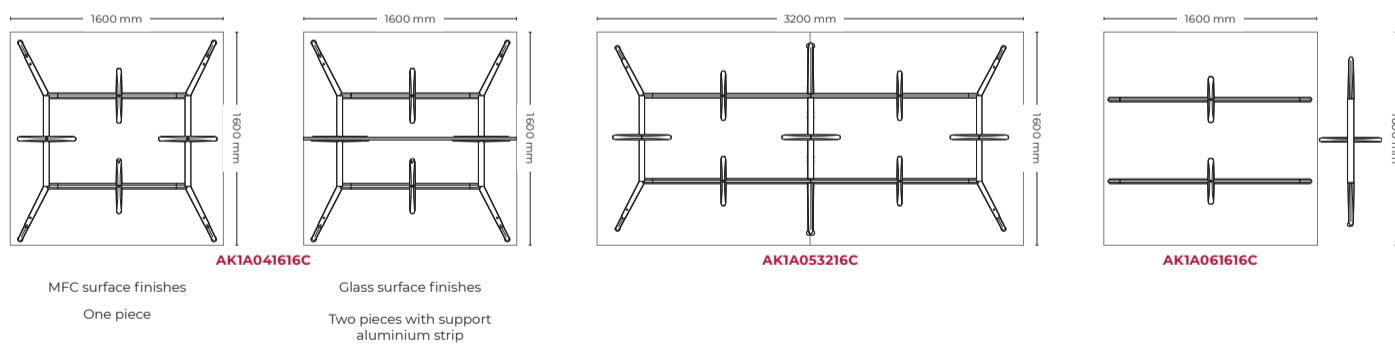
Meeting tables · Width 1400 mm



Meeting tables · Width 1600 mm



Double and meeting tables · Width 1600 mm



MFC surface finishes  
One piece

Glass surface finishes  
Two pieces with support  
aluminium strip

Technical sheet

Individual tables



- 1 Surfaces in different finishes and colors.
- 2 Aluminum arms with support disc for glass surfaces.
- 3 Optional accessories hung on the table structure.
- 4 Aluminum structure in different finishes.
- 5 Aluminum levelers with anti-slip soleplate. Height 740,5 mm.

Multi-position tables



- 1 Surfaces in different finishes and colors.
- 2 Optional accessories placed on the table surface.
- 3 Aluminum arms with support disc for surfaces.
- 4 Suspended electrification trunking on the deck with access to wiring from the surface.
- 5 Aluminum structure in different finishes.
- 6 Aluminum levelers with anti-slip soleplate. Height 740,5 mm.

Surface finishes

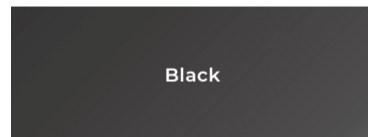
MFC · 19 mm



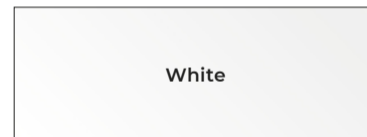
Compact Laminate · 13 mm



Laminated safety glass · 5 + 5 mm / 6 + 6 mm



Tempered glass · 10 mm



Structural finishes

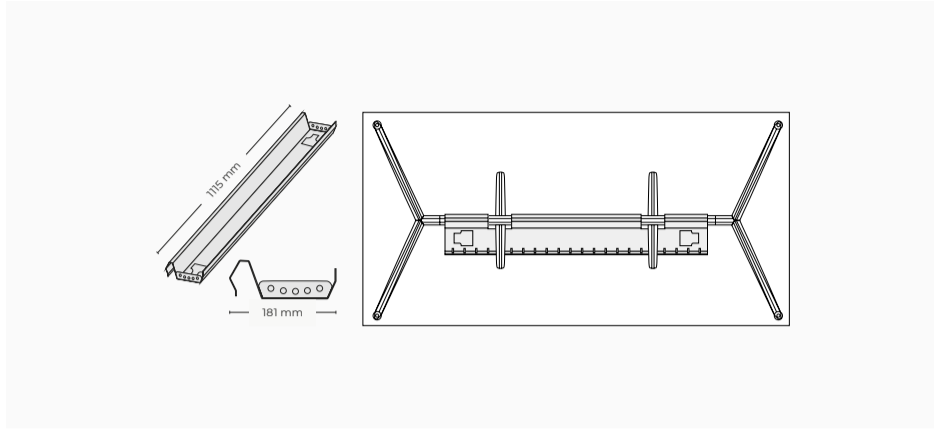
The legs are made of die-cast aluminum, while the crossbars are made of extruded aluminum. They are available in four finishes:



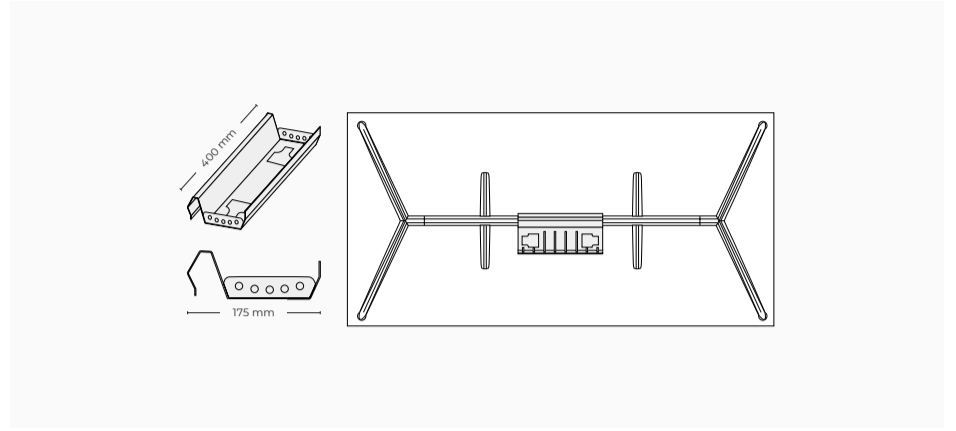
## Optional accessories

### Electrification systems

**Lower metal channel** with large capacity for wiring and connections. Provides maximum accessibility, optimizing the work surface, allowing optimal cable management.



Individual 1150 mm steel tray for individual 1800 and 2000 mm tables.



Individual steel tray of 40 cm. for individual tables of 160, 180, 200 and 220 cm in length.

### Ecodesign

Recycled materials	77,47%
Production	100%
Transport	100%
Use	Easy
Disposal	98,54%

**Recycled materials:** Maximum use of materials to eliminate waste and minimize residues. Use of recyclable materials and recycled materials in components that do not affect functionality and durability. **Production:** Maximum optimization of energy use. Minimum environmental impact. State-of-the-art technological systems. Zero wastewater discharge. VOC-free coatings. Processes free of heavy metals, phosphates, OC and COD. **Transport:** Dismountable systems. Volumes that facilitate space optimization. Maximum reduction of energy consumption for transport. **Use:** Quality and guarantee. Long useful life. Possibility of substitution and replacement of elements. **Disposal:** Waste reduction. Reuse system of supplier-manufacturer packaging. Easy separation of components. Solvent-free water-based printing inks on packaging.

### Standards

Arkitek has passed the tests carried out in our laboratory and the tests performed at the Technological Institute of Furniture (AIDIMA) corresponding to the standards:

Regulations	Description
UNE-EN 527-1:2011	Office furniture. Work tables. <b>Part 1:</b> Dimensions.
UNE-EN 527-2:2017	Office furniture. Work tables. <b>Part 2:</b> Requirements for safety, strength and durability.
UNE-EN 15372:17	Furniture. Strength, durability and safety. Requirements for domestic tables.
UNE-EN 1730:13	Household furniture. Tables. Test methods for the determination of strength, durability and stability.

### Certificates






















































How to code a reference

			
<b>Q Wiring Access</b>	<b>R Wiring Access</b>	<b>P Wiring Access</b>	
Maximum opening: 110°	Maximum opening: 180°	Maximum opening: 180°	
<ul style="list-style-type: none"> <li>• Black die-cast aluminium frame</li> <li>• Die-cast aluminium lid</li> <li>• Aluminium guides for adjustment according to the thickness of the DESK-TOP FINISHES between 13 and 30 mm</li> <li>• Dimensions: 30,5 x 12,1 cm</li> </ul>	<ul style="list-style-type: none"> <li>• Melamine lid of the same finish as the DESK-TOP FINISHES</li> <li>• Black Bristle Brush</li> <li>• Black die-cast aluminium frame</li> <li>• Aluminium guides for adjustment according to the thickness of the DESK-TOP FINISHES between 13 and 30 mm</li> <li>• Complete opening in 180° by means of hinges.</li> <li>• Dimensions: 30,5 x 12,1 cm</li> </ul>	<ul style="list-style-type: none"> <li>• The wiring access P only includes the cut-out in the table top.</li> <li>• If you order the desking with the optional PC wiring access, please refer to the accessories section to order the integrated power and data connection in the desk top.</li> <li>• Compact solution for integrated power and data connection with easy workstation access.</li> <li>• Different configuration combinations for a wide range of applications.</li> <li>• Perimeter frame in black aluminium.</li> <li>• Optional integrated aluminium cover to protect connections against dust and dirt. Available in black and white.</li> <li>• Total dimensions: 241 x 73 mm</li> <li>• Total dimensions cover: 257 x 87 mm</li> <li>• Junction box top surface dimensions: 225 x 60 mm</li> </ul>	

-Models with this standard cable access has the icon next to the code  
 -Desk price with the cable access is as per the attached table.  
 -To order different desks which the electrification access is not standard, please check sales team.  
 -To order desks with cable access, please add the corresponding letter according to the desired placement, at the end of the reference:

WIRING ACCESS			
	<b>FRONT CENTERED ACCESS</b>	<b>CENTERED ACCESS</b>	
			

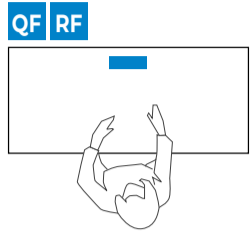
**IMPORTANT NOTE:**  
 The combination of wired access is carried out in the following way:  
 (If in any case you want the upper access in different finishing established, the customer must indicate it on the order.)

MELAMINE DESK-TOP FINISHES FINISHES AND STRUCTURE		COMBINATIONS OF FINISHES OFFERED			
DESK-TOP FINISHES	Structure	Q WIRING ACCES	R WIRING ACCES	P WIRING ACCES	
WHITE	WHITE				
	BLACK				
	POLISHED				
LIME OAK	WHITE				
	BLACK				
	POLISHED				
LIGHT OAK	WHITE				
	BLACK				
	POLISHED				
CHESTNUT	WHITE				
	BLACK				
	POLISHED				
DARK OAK	WHITE				
	BLACK				
	POLISHED				
BLACK	WHITE				
	BLACK				
	POLISHED				

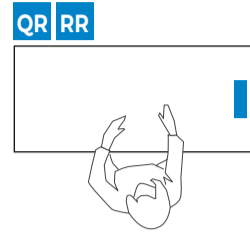
Superior cable access location to cabling and connections

Rectangular desks - 80 cm wide

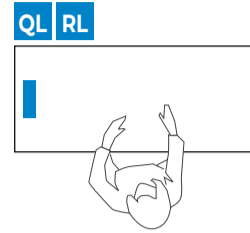
Front access



Right lateral access

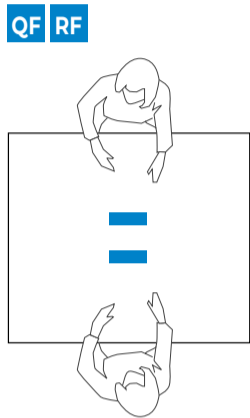


Left lateral access

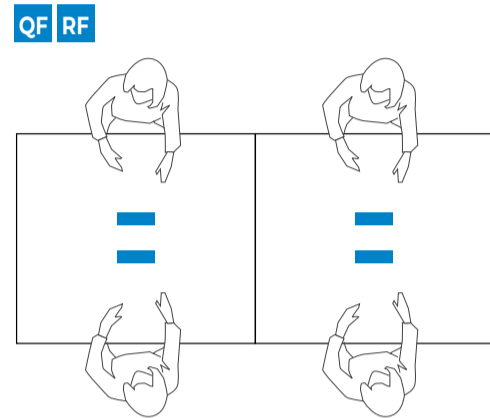


Twin and progressive desks - 160 cm wide

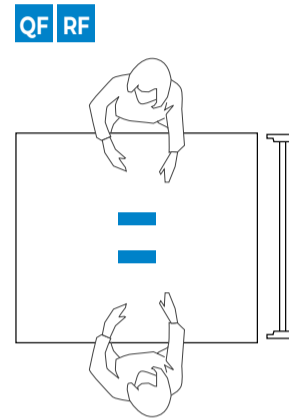
Front access



Front access

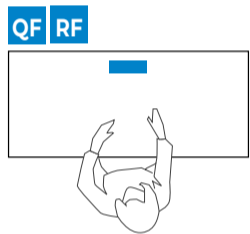


Front access

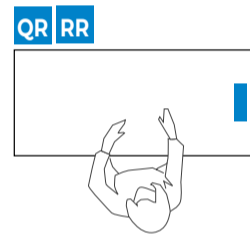


Executive and meeting desks - 100 cm wide

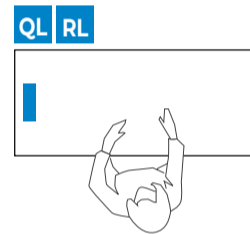
Front access



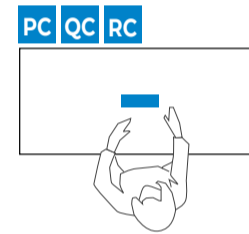
Right lateral access



Left lateral access

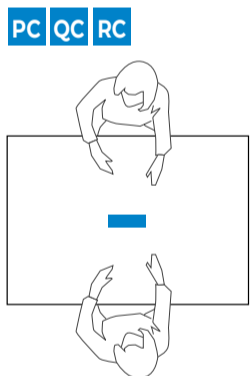


Centered access

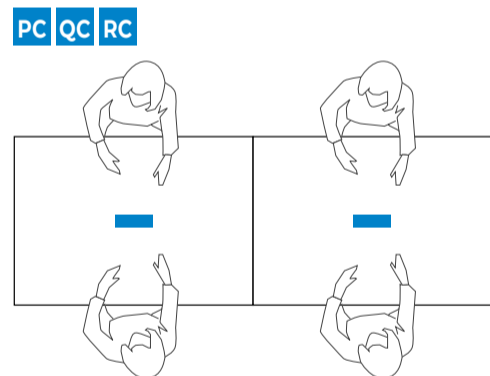


Meeting desks - 120 / 140 / 160 cm wide

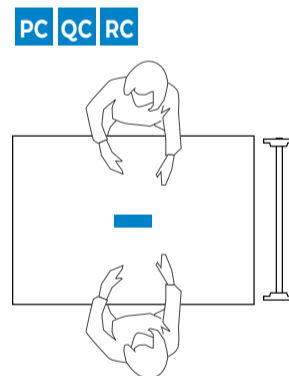
Centered access



Centered access



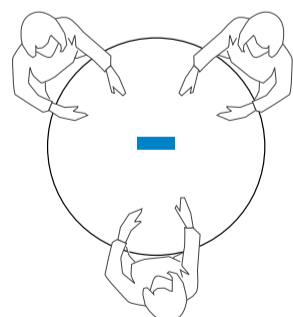
Centered access



Meeting desks - 160 cm diameter

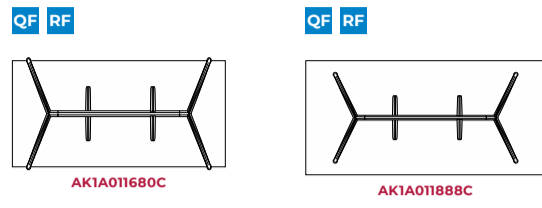
Centered access

PC QC RC

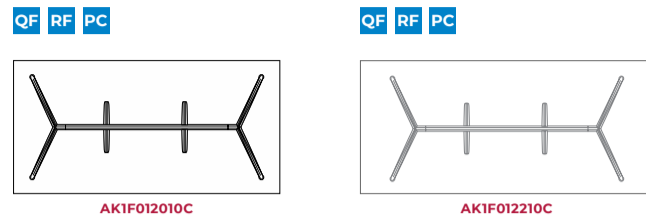


Program of tables

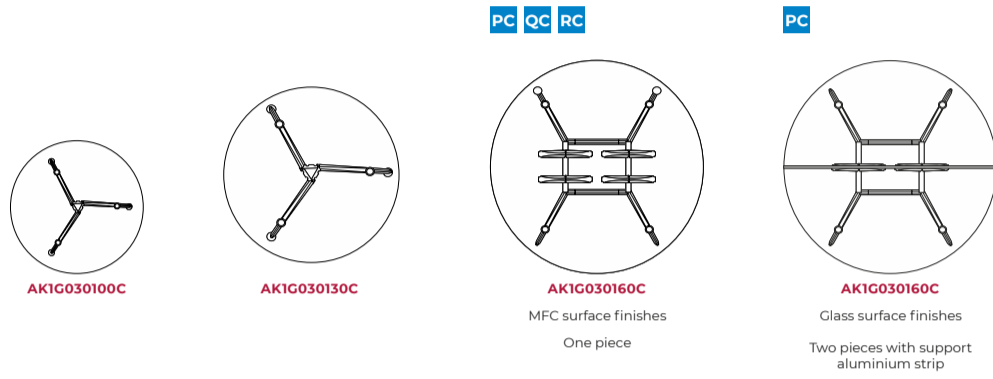
Individual operating tables · Width 800/880 mm



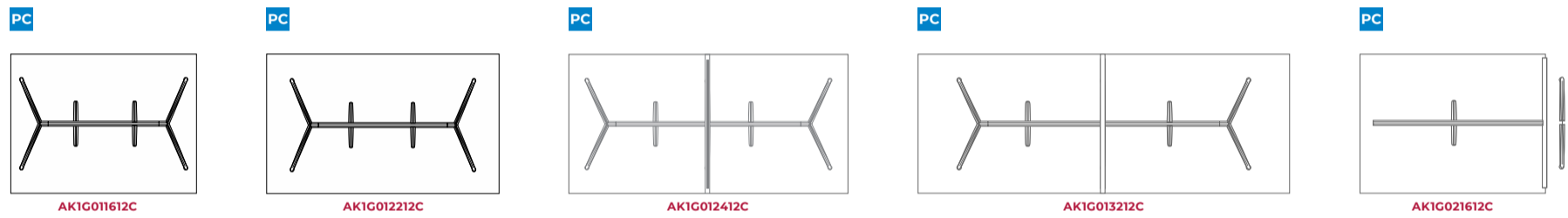
Meeting tables · Width 1000 mm



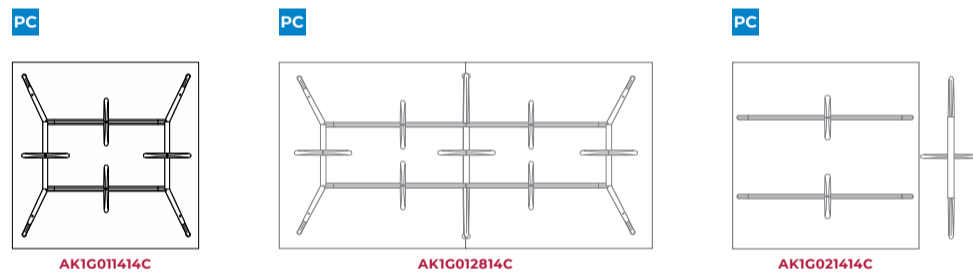
Meeting tables · Round



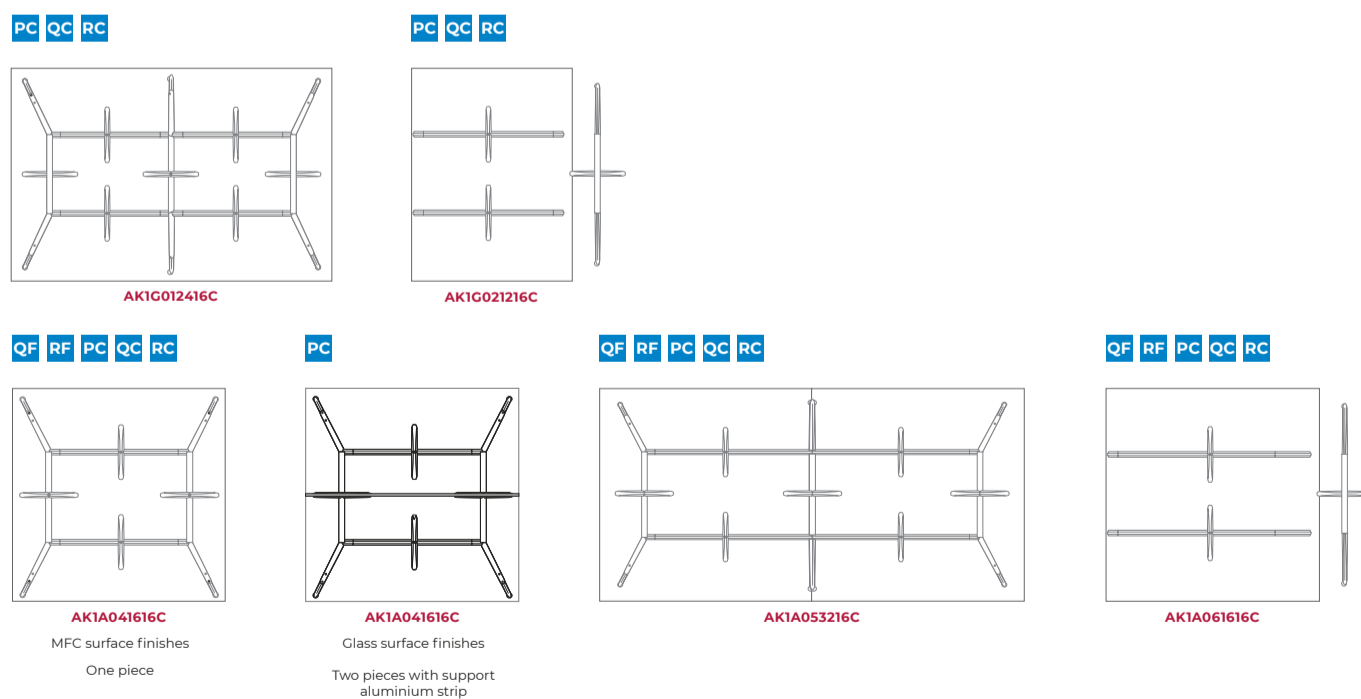
Meeting tables · Width 1200 mm

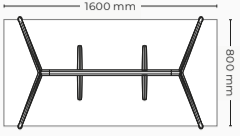
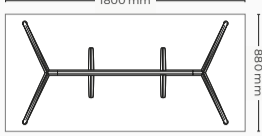


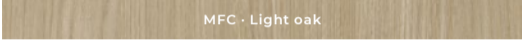

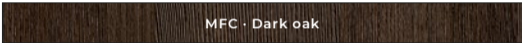




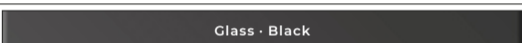
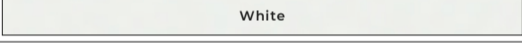

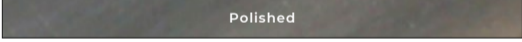


Meeting tables · Width 1400 mm



Double, progression and meeting tables · Width 1600 mm

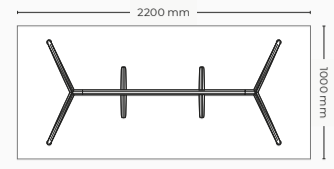
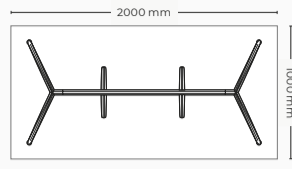


Individual operating tables and direction 800 / 880 mm wide			
Measures		1600 x 800 mm	1800 x 880 mm
Levelers		Height 740 mm	Height 740 mm
Reference		<b>AKIA011680C</b>	<b>AKIA011888C</b>
TYPE OF STRUCTURE			
Inclined legs	<b>C</b>	964,60	991,20
SUPPORT			
Levelers	<b>F</b>		
DESK-TOP FINISHES			
	<b>M00</b>		
	<b>M11</b>		
	<b>M10</b>		
	<b>M07</b>		
	<b>M14</b>		
	<b>M03</b>	+ 180,60	+ 180,60
	<b>F30</b>	+ 439,60	+ 470,40
	<b>V51</b>	+ 574,00	+ 597,80
	<b>V52</b>	+ 621,60	+ 747,60
	<b>V59</b>	+ 621,60	+ 747,60
STRUCTURE			
	<b>00</b>		
	<b>08</b>		
	<b>09</b>	+ 408,80	+ 411,60
OPTIONAL WIRED ACCESS			
MFC	<b>QF</b>	+ 72,80	+ 72,80
	<b>RF</b>	+ 95,20	+ 95,20
Black MFC Anti-fingerprint	<b>QF</b>	+ 72,80	+ 72,80
Compact Laminate	<b>QF</b>	+ 75,60	+ 75,60



**Steering tables**

Width 1000 mm



<b>Measures</b>	2000 x 1000 mm	2200 x 1000 mm
<b>Levelers</b>	Height 740 mm	Height 740 mm
<b>Reference</b>	<b>AKIF012010C</b>	<b>AKIF012210C</b>

TYPE OF STRUCTURE

Inclined legs	<b>C</b>	1.040,20	1.096,20
---------------	----------	----------	----------

SUPPORT

Levelers	<b>F</b>		
----------	----------	--	--

DESK-TOP FINISHES

MFC · White	<b>M00</b>		
MFC · Lime oak	<b>M11</b>		
MFC · Light oak	<b>M10</b>		
MFC · Chestnut	<b>M07</b>		
MFC · Dark oak	<b>M14</b>		
MFC · Anti-fingerprint	<b>M03</b>	+ 267,40	+ 274,40
Compact Laminate · White	<b>F30</b>	+ 513,80	+ 564,20
Glass · Transparent	<b>V51</b>	+ 666,40	
Glass · White	<b>V52</b>	+ 897,40	
Glass · Black	<b>V59</b>	+ 897,40	+ 924,00

STRUCTURE

White	<b>00</b>		
Black	<b>08</b>		
Polished	<b>09</b>	+ 413,00	+ 415,80

OPTIONAL WIRED ACCESS

MFC	<b>PC</b>	+ 30,80	+ 30,80
	<b>QF</b>	+ 72,80	+ 72,80
	<b>RF</b>	+ 95,20	+ 95,20
Black MFC Anti-fingerprint	<b>PC</b>	+ 30,80	+ 30,80
	<b>QF</b>	+ 72,80	+ 72,80
Compact Laminate	<b>PC</b>	+ 30,80	+ 30,80
	<b>QF</b>	+ 75,60	+ 75,60
Glass	<b>PC</b>	+ 231,00	+ 231,00





**IMPORTANT NOTE:**  
When ordering the table with the optional **PC wiring access**, please refer to the accessories section to order the power and data connection integrated in the table top. The optional **PC wiring access** only includes the cut-out in the table top.

[CLICK TO COMPLEMENTS](#)

Meeting tables

Circular

			
Measures	Ø 1000 mm	Ø 1300 mm	Ø 1600 mm
Levelers	Height 740 mm	Height 740 mm	Height 740 mm
Reference	<b>AK1G030100C</b>	<b>AK1G030130C</b>	<b>AK1G030160C</b>






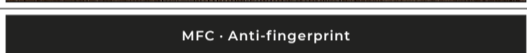
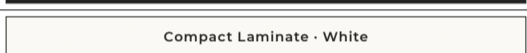



TYPE OF STRUCTURE

Inclined legs	<b>C</b>	609,00	652,40	1.359,40
---------------	----------	--------	--------	----------

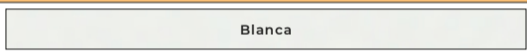

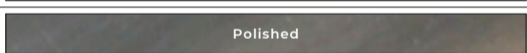
SUPPORT

Levelers	<b>F</b>			
----------	----------	--	--	--

DESK-TOP FINISHES

	<b>M00</b>			
	<b>M11</b>			
	<b>M10</b>			
	<b>M07</b>			
	<b>M14</b>			
	<b>M03</b>	+ 133,00	+ 282,80	+ 637,00
	<b>F30</b>	+ 312,20	+ 567,00	
	<b>V51</b>	+ 540,40	+ 588,00	+ 1.148,00
	<b>V52</b>	+ 634,20	+ 861,00	+ 1.232,00
	<b>V59</b>	+ 634,20	+ 861,00	+ 1.232,00

STRUCTURE

	<b>00</b>			
	<b>08</b>			
	<b>09</b>	+ 294,00	+ 299,60	+ 546,00

OPTIONAL WIRED ACCESS

MFC	<b>PC</b>			+ 30,80
	<b>QC</b>			+ 72,80
	<b>RC</b>			+ 95,20
Black MFC Anti-fingerprint	<b>PC</b>			+ 30,80
	<b>QC</b>			+ 72,80
Glass (*Two wired access)	<b>PC</b>			+ 462,00 *

\* IMPORTANT NOTE:

The reference **AK1G030160C** with glass desk-top finishes the top surface are two pieces with support aluminium strip

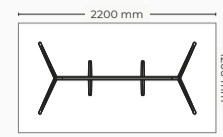
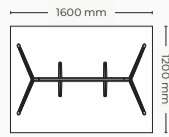


IMPORTANT NOTE:

When ordering the table with the optional **PC wiring access**, please refer to the accessories section to order the power and data connection integrated in the table top. The optional **PC wiring access** only includes the cut-out in the table top.

[CLICK TO COMPLEMENTS](#)

**Meeting tables**  
 Width 1200 mm



<b>Measures</b>	1600 x 1200 mm	2200 x 1200 mm
<b>Levelers</b>	Height 740 mm	Height 740 mm
<b>Reference</b>	<b>AK1G011612C</b>	<b>AK1G012212C</b>

TYPE OF STRUCTURE			
Inclined legs	<b>C</b>	1.034,60	1.138,20

SUPPORT			
Levelers	<b>F</b>		

DESK-TOP FINISHES			
MFC · White	<b>M00</b>		
MFC · Lime oak	<b>M11</b>		
MFC · Light oak	<b>M10</b>		
MFC · Chestnut	<b>M07</b>		
MFC · Dark oak	<b>M14</b>		
MFC · Black Anti-fingerprint	<b>M03</b>	+ 273,00	+ 603,40
Glass · Transparent	<b>V51</b>	+ 676,20	+ 1.433,60
Glass · White	<b>V52</b>	+ 845,60	
Glass · Black	<b>V59</b>	+ 845,60	+ 1.643,60

STRUCTURE			
White	<b>00</b>		
Black	<b>08</b>		
Polished	<b>09</b>	+ 408,80	+ 415,80

OPTIONAL WIRED ACCESS			
MFC	<b>PC</b>	+ 30,80	+ 30,80
Glass	<b>PC</b>	+ 231,00	+ 231,00

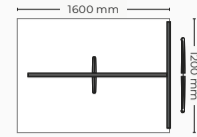
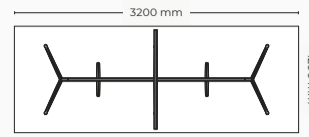
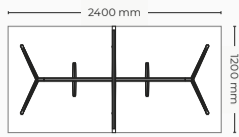


**IMPORTANT NOTE:**  
 When ordering the table with the optional **PC wiring access**, please refer to the accessories section to order the power and data connection integrated in the table top. The optional **PC wiring access** only includes the cut-out in the table top.

[CLICK TO COMPLEMENTS](#)

**Meeting tables**

Width 1200 mm



<b>Measures</b>	2400 x 1200 mm	3200 x 1200 mm	1600 x 1200 mm - Progression
<b>Levelers</b>	Height 740 mm	Height 740 mm	Height 740 mm
<b>Reference</b>	<b>AK1G012412C</b>	<b>AK1G013212C</b>	<b>AK1G021612C</b>

TYPE OF STRUCTURE

Inclined legs	<b>C</b>	1.505,00	1.729,00	791,00
---------------	----------	----------	----------	--------

SUPPORT

Niveladores	<b>F</b>			
-------------	----------	--	--	--

DESK-TOP FINISHES

MFC - White	<b>M00</b>			
MFC - Lime oak	<b>M11</b>			
MFC - Light oak	<b>M10</b>			
MFC - Chestnut	<b>M07</b>			
MFC - Dark oak	<b>M14</b>			
MFC - Black Anti-fingerprint	<b>M03</b>	+ 462,00	+ 543,20	+ 273,00
Glass - Transparent	<b>V51</b>	+ 1.072,40	+ 1.352,40	+ 676,20
Glass - White	<b>V52</b>		+ 1.691,20	+ 845,60
Glass - Black	<b>V59</b>	+ 1.335,60	+ 1.691,20	+ 845,60

STRUCTURE

White	<b>00</b>			
Black	<b>08</b>			
Polished	<b>09</b>	+ 617,40	+ 628,60	+ 211,40

OPTIONAL WIRED ACCESS

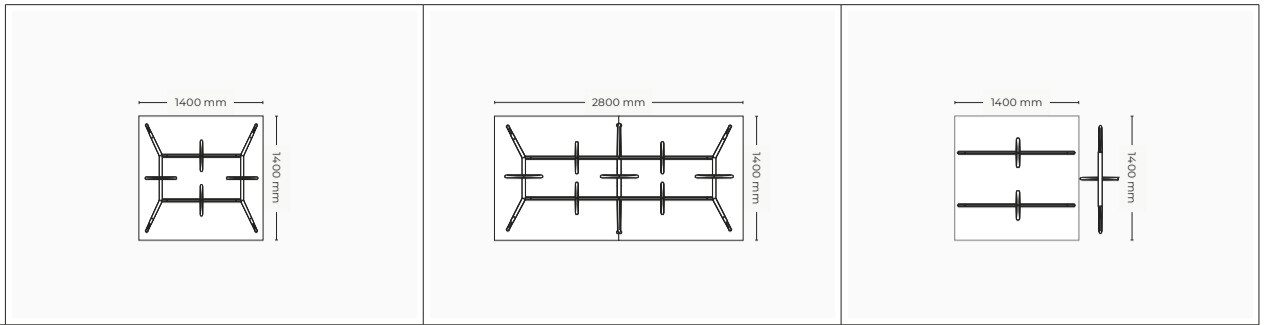
MFC	<b>PC</b>	+ 61,60	+ 61,60	+ 30,80
Glass	<b>PC</b>	+ 462,00	+ 462,00	+ 231,00



**IMPORTANT NOTE:**  
When ordering the table with the optional **PC wiring access**, please refer to the accessories section to order the power and data connection integrated in the table top. The optional **PC wiring access** only includes the cut-out in the table top.

[CLICK TO COMPLEMENTS](#)

**Meeting tables**  
Width 1400 mm



<b>Measures</b>	1400 x 1400 mm	2800 x 1400 mm	1400 x 1400 mm - Progression
<b>Levelers</b>	Height 740 mm	Height 740 mm	Height 740 mm
<b>Reference</b>	<b>AK1G011414C</b>	<b>AK1G012814C</b>	<b>AK1G021414C</b>

TYPE OF STRUCTURE				
Inclined legs	<b>C</b>	1.418,20	2.487,80	1.162,00

SUPPORT				
Levelers	<b>F</b>			

DESK-TOP FINISHES				
MFC · White	<b>M00</b>			
MFC · Lime oak	<b>M11</b>			
MFC · Light oak	<b>M10</b>			
MFC · Chestnut	<b>M07</b>			
MFC · Dark oak	<b>M14</b>			
MFC · Black Anti-fingerprint	<b>M03</b>	+ 635,60	+ 1.271,20	+ 635,60
Glass · Transparent	<b>V51</b>	+ 1.143,80	+ 2.287,60	+ 1.143,80
Glass · White	<b>V52</b>	+ 1.257,20	+ 2.514,40	+ 1.257,20
Glass · Black	<b>V59</b>	+ 1.257,20	+ 2.514,40	+ 1.257,20

STRUCTURE				
White	<b>00</b>			
Black	<b>08</b>			
Polished	<b>09</b>	+ 546,00	+ 935,20	+ 358,40

OPTIONAL WIRED ACCESS				
MFC	<b>PC</b>	+ 30,80	+ 61,60	+ 30,80
Glass	<b>PC</b>	+ 231,00	+ 462,00	+ 231,00

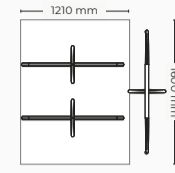
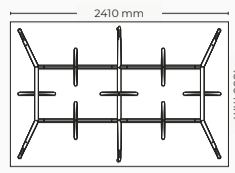


**IMPORTANT NOTE:**  
When ordering the table with the optional **PC wiring access**, please refer to the accessories section to order the power and data connection integrated in the table top. The optional **PC wiring access** only includes the cut-out in the table top.

[CLICK TO COMPLEMENTS](#)

**Meeting tables**

Width 1600 mm



<b>Measures</b>	2410 x 1600 mm	1210 x 1600 mm - Progresión
<b>Levelers</b>	Height 740 mm	Height 740 mm
<b>Reference</b>	<b>AK1G012416C</b>	<b>AK1G021216C</b>

TYPE OF STRUCTURE

Inclined legs	<b>C</b>	2.612,40	1.156,40
---------------	----------	----------	----------

SUPPORT

Levelers	<b>F</b>		
----------	----------	--	--

DESK-TOP FINISHES

MFC · White	<b>M00</b>		
MFC · Lime oak	<b>M11</b>		
MFC · Light oak	<b>M10</b>		
MFC · Chestnut	<b>M07</b>		
MFC · Dark oak	<b>M14</b>		
MFC · Black Anti-fingerprint	<b>M03</b>	+ 543,20	+ 273,00
Glass · Transparent	<b>V51</b>	+ 1.352,40	+ 676,20
Glass · White	<b>V52</b>	+ 1.691,20	+ 845,60
Glass · Black	<b>V59</b>	+ 1.691,20	+ 845,60

STRUCTURE

White	<b>00</b>		
Black	<b>08</b>		
Polished	<b>09</b>	+ 907,20	+ 352,80

OPTIONAL WIRED ACCESS

MFC	<b>PC</b>	+ 61,60	+ 30,80
	<b>QC</b>	+ 145,60	+ 72,80
	<b>RC</b>	+ 190,40	+ 95,20
Black Anti-Fingerprint MFC	<b>PC</b>	+ 61,60	+ 30,80
	<b>QC</b>	+ 145,60	+ 72,80
Glass	<b>PC</b>	+ 462,00	+ 231,00

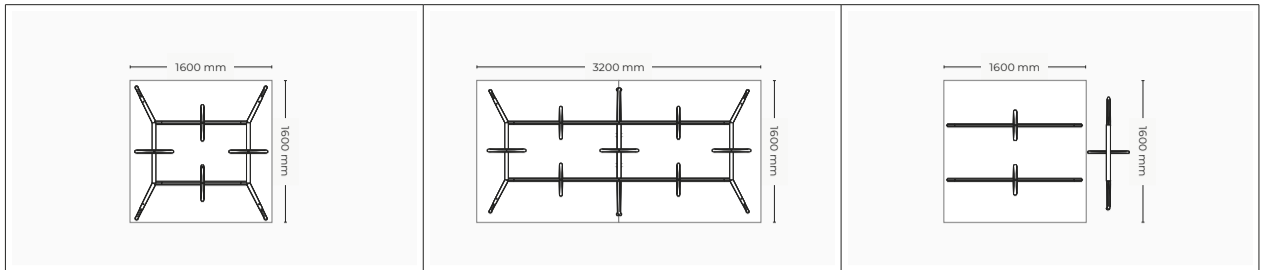


**IMPORTANT NOTE:**  
When ordering the table with the optional **PC wiring access**, please refer to the accessories section to order the power and data connection integrated in the table top. The optional **PC wiring access** only includes the cut-out in the table top.

[CLICK TO COMPLEMENTS](#)

**Double & meeting tables**

Width 1600 mm



<b>Measures</b>	1600 x 1600 mm	3200 x 1600 mm	1600 x 1600 mm - Progression
<b>Levelers</b>	Height 740 mm	Height 740 mm	Height 740 mm
<b>Reference</b>	<b>AKIA041616C</b>	<b>AKIA053216C</b>	<b>AKIA061616C</b>

TYPE OF STRUCTURE			
Inclined legs	<b>C</b>	1.484,00	2.619,40

SUPPORT			
Levelers	<b>F</b>		

DESK-TOP FINISHES			
MFC · White	<b>M00</b>		
MFC · Lime oak	<b>M11</b>		
MFC · Light oak	<b>M10</b>		
MFC · Chestnut	<b>M07</b>		
MFC · Dark oak	<b>M14</b>		
MFC · Black Anti-fingerprint	<b>M03</b>	+ 637,00	+ 1.274,00
* Glass · Transparent	<b>V51</b>	+ 1.192,80	
* Glass · White	<b>V52</b>	+ 1.313,20	
* Glass · Black	<b>V59</b>	+ 1.313,20	

STRUCTURE			
White	<b>00</b>		
Black	<b>08</b>		
Polished	<b>09</b>	+ 585,20	+ 956,20

OPTIONAL WIRED ACCESS			
MFC	<b>PC</b>	+ 30,80	+ 61,60
	<b>QC</b>	+ 72,80	+ 145,60
	<b>QF</b>	+ 145,60	+ 291,20
	<b>RC</b>	+ 95,20	+ 190,40
	<b>RF</b>	+ 190,40	+ 380,80
Black MFC Anti-fingerprint	<b>PC</b>	+ 30,80	+ 61,60
	<b>QC</b>	+ 72,80	+ 145,60
	<b>QF</b>	+ 145,60	+ 291,20
Glass (*Two wired access)	<b>PC</b>	+ 462,00 *	

**\* IMPORTANT NOTE:**  
The reference **AKIA041616C** with glass desk-top finishes the top surface are two pieces with support aluminium strip



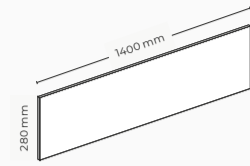
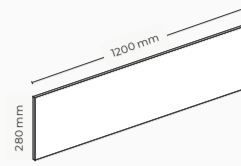
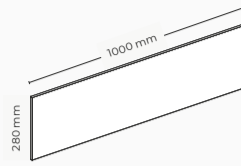
**IMPORTANT NOTE:**  
When ordering the table with the optional **PC wiring access**, please refer to the accessories section to order the power and data connection integrated in the table top. The optional **PC wiring access** only includes the cut-out in the table top.

[CLICK TO COMPLEMENTS](#)

Available complements

Modesty panel

Only for individual desks



Measures	1000 x 280 mm	1200 x 280 mm	1400 x 280 mm
Compatibility	1600 mm desks	1800 mm desks	2000 / 2200mm desks
Packs	Pack 1 unit	Pack 1 unit	Pack 1 unit
Reference	<b>XAKFA11028</b>	<b>XAKFA11228</b>	<b>XAKFA11428</b>

ANCHORING FINISH

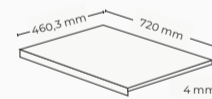
White	<b>00</b>	95,20	102,20	106,40
Black	<b>08</b>			
Polished	<b>09</b>	+ 18,20	+ 18,20	+ 18,20

SURFACE FINISH

MFC · White	<b>M00</b>			
MFC · Locust	<b>M11</b>			
MFC · Oak	<b>M10</b>			
MFC · Chestnut	<b>M07</b>			
MFC · Ash	<b>M14</b>			
MFC · Black	<b>M08</b>			
Phenolic · White	<b>F30</b>	+ 70,00	+ 88,20	+ 103,60
Aluminium · White	<b>A00</b>	+ 112,00	+ 127,40	+ 151,20
Aluminium · Aluminium	<b>A02</b>			
Aluminium · Black	<b>A08</b>			
Glass · White	<b>V52</b>		+ 170,80	+ 184,80
Glass · Black	<b>V59</b>			

Pad manager

Desk Protector





MEASURES	720 x 463 x 4 mm
REFERENCE	<b>PAD5</b>



INTEGRAL POLYURETHANE

Black	<b>9</b>	72,80
Red	<b>7</b>	




<b>Cable risers</b> Flexible polystyrene					
	MEASURES	800 x 40,5 mm / Ø 40,5 mm		800 x 40,5 mm / Ø 70 mm	
	COMPATIBILITY	For use with P, Q and R access containers.			
	MINIMUM UNITS ORDER	3 units · Price for 1 unit		3 units · Price for 1 unit	
	REFERENCE	39425		39525	

FLEXIBLE POLYSTYRENE FINISH				
White	0	22,40	26,60	
Black	8			

<b>Cable risers</b> Sheet metal					
	MEASURES	520 x 80 x 50 mm		625 x 150 x 100 mm	
	COMPATIBILITY	For use on single, quadruple and double progression desks.			
	REFERENCE	5070		5071	

FINISHING SHEET METAL				
White	0	112,00	134,40	
Black	8			

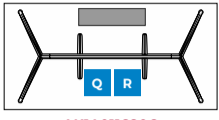
<b>Cable risers</b> Braided textile wrap					
	PACKS	Pack 1 unit		Pack 4 units	
	MEASURES	750 mm / Ø 30 mm			
	CHARACTERISTICS	Zippered for quick and easy installation. Offers additional protection against flame and abrasion.			
	REFERENCE	39431		39434	

FINISHING FABRIC				
Black	8	36,40	131,60	

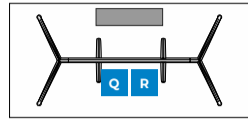
Compatibility of cable container for individual and meeting desks

**IMPORTANT NOTE:**

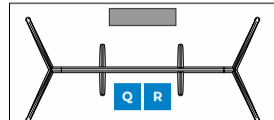
Arkitek desking (operating desking) and tables (meeting tables) cannot be fitted with the cable container **with the PC wiring access.**



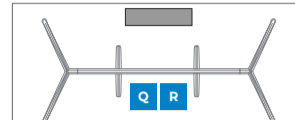
AKIA011680C



AKIA011888C



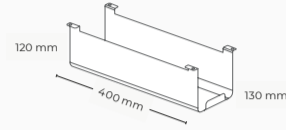
AKIF012010C



AKIF012210C

**Accessories electrification systems**

Individual desks



MEASURES	400 x 120 x 130 mm	
COMPATIBILITY	Container for electrification accessories with <b>Q and R wiring access.</b>	
PACKS	Pack 1 unit	Pack 2 units
REFERENCE	<b>CQR11</b>	<b>CQR12</b>

FINISHES

White	0	68,60	133,00
Black	8		

Explanation of use of the cable tray - desks de reunión

Arkitek includes a new cable management system for individual use only. The tray is hold in the central beam. Two sizes available:

-40 cm Channel for individual use 160, 180, 200 and 220cm desks.

-111,5 cm Channel for individual use 180, 200 and 220cm desks.



AKIA011680C



AKIA011888C



AKIF012010C



AKIF012210C



AKIA011888C



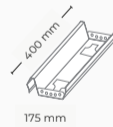
AKIF012010C



AKIF012210C

**Simple Cable tray**

Individual desks



175 mm



181 mm

Measures	400 x 175 mm	1115 x 181 mm
Compatibility	1600 / 1800 / 2000 / 2200 mm desks	1800 / 2000 / 2200 mm desks
Packs	Pack 1 unit	Pack 1 unit
Reference	<b>XAKTC1A10417</b>	<b>XAKTC1A51118</b>

TYPE OF ANCHOR

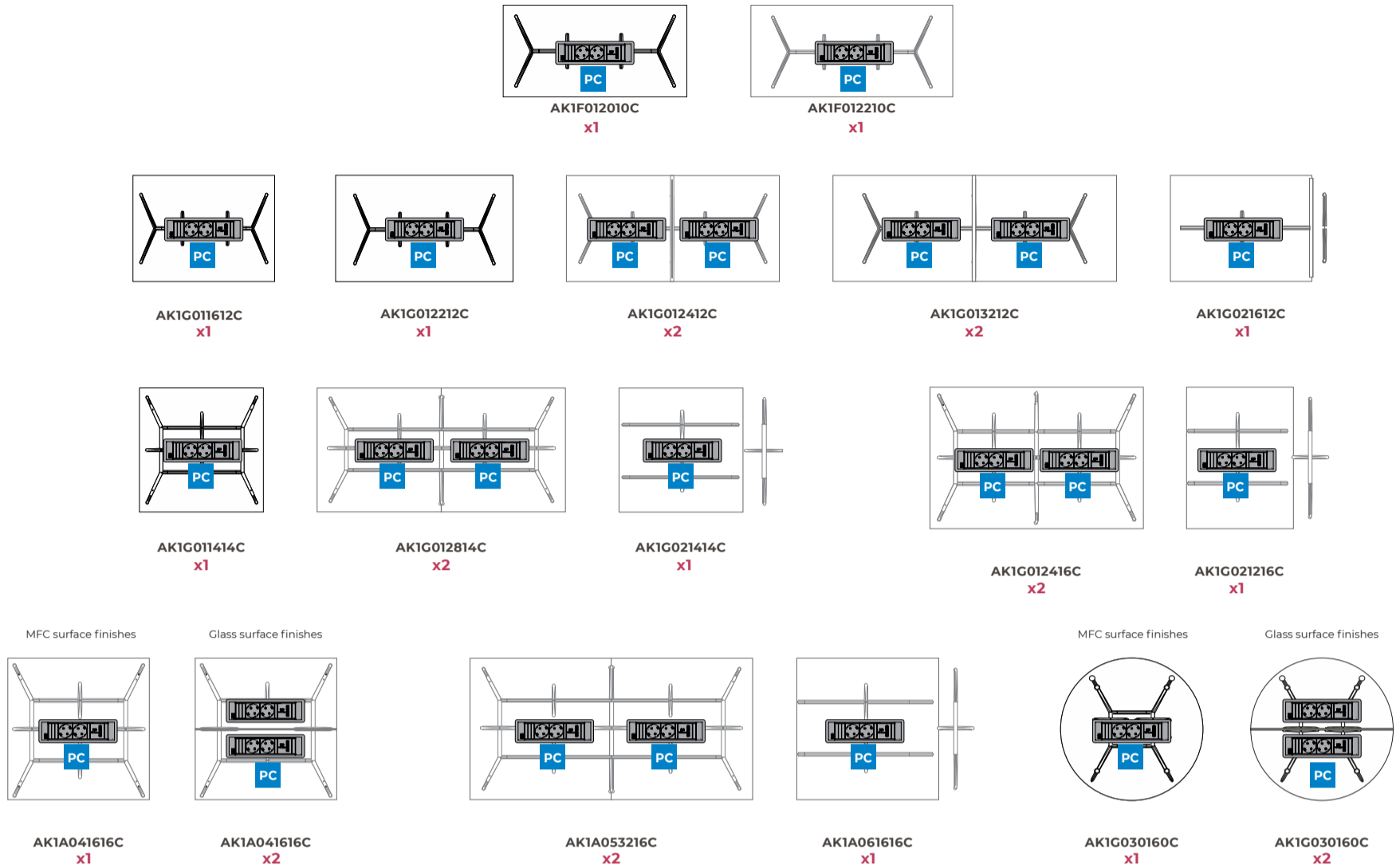
Fixed	<b>A</b>	46,20	88,20
-------	----------	-------	-------

SURFACE FINISH

Steel · White	<b>C00</b>		
Steel · Black	<b>C08</b>		

Power and data connection compatibility for meeting desks

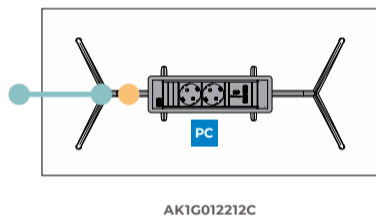
Locate the requested table model to order the necessary power connection units for all meeting desks.



Example of power connection

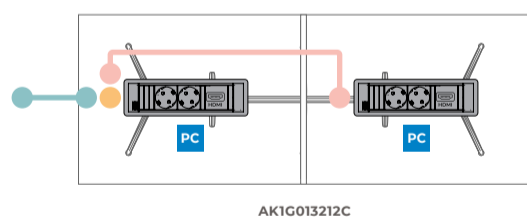
Please refer to the following examples to order all the components required for the desired configuration. The **GX21** mains power cable must always be ordered. The power distributor **GX22** is included in the power connection with USB charging. In case of ordering a table with progressive desk and **power connection with HDMI**, the **GX22 connection spread kit** must be ordered for the progressive desk.

EXAMPLE 01



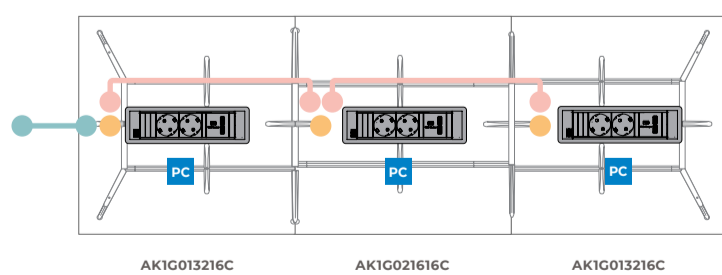
COMPONENTS	DESCRIPTION	UNITS
AK1G012212CCFM0000PC	Meeting table 220 x 120 cm with PC cable access	x1
XELBCP122081EU99	Power connection with 2 sockets + 2 USB charging sockets and without cover	x1
· GX21	2 metres extension cable, end power entry. EU · 220v	x1
· GX22	Connection spread kit	<b>INCLUDED</b>

EXAMPLE 02



COMPONENTS	DESCRIPTION	UNITS
AK1G013212CCFM0000PC	Meeting table 320 x 160 cm with PC cable access	x1
XELBCP222081EU99	Power connection with 2 sockets + 1 HDMI and without cover	x2
· GX21	2 metres extension cable, end power entry. EU · 220v	x1
· GX22	Connection spread kit	x1
· GX20	Extension cable (1'5 m.)	x1

EXAMPLE 03

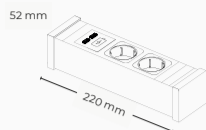
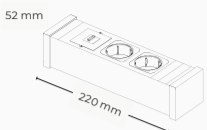
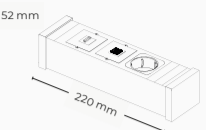


COMPONENTS	DESCRIPTION	UNITS
AK1G013216CCFM0000PC	Meeting table 320 x 160 cm with PC cable access	x1
AK1G021616CCFM0000PC	Extension table 160 x 160 cm with PC cable access	x1
XELBCP122081EU99	Power connection with 2 sockets + 2 USB charging sockets and without cover	x3
· GX21	2 metres extension cable, end power entry. EU · 220v	x1
· GX22	Connection spread kit	<b>INCLUDED</b>
· GX20	Extension cable (1'5 m.)	x2

**IMPORTANT NOTE:**

When ordering a power and data connection for a transparent glass top surface, it is compulsory to order the additional cover plate to conceal the cables.

**Power and data connection**  
Meeting desks

			
<b>COMPONENTS</b>	2 plugs + 2 USB charging sockets <b>GX22 INCLUDED</b> (Connection spread kit)	2 plugs + 1 HDMI	1 plug + 1 HDMI + 2 USB charging sockets <b>GX22 INCLUDED</b> (Connection spread kit)
<b>COMPATIBILITY</b>	Integrated power and data connection for meeting desks with PC wiring access		
<b>PACKS</b>	Pack 1 unit	Pack 1 unit	Pack 1 unit
<b>REFERENCE</b>	<b>XELBCP122</b>	<b>XELBCP222</b>	<b>XELBCP322</b>

**FRAME FINISH / INITIAL PRICE**

Black	<b>08</b>	315,00	240,80	380,80
-------	-----------	--------	--------	--------

**CONNECTIVITY**

US · 120V	<b>1US</b>			
EU · 220V	<b>1EU</b>			
UK · 220V	<b>1UK</b>			

**OPTIONAL TOP COVER**






Without cover	<b>99</b>			
White	<b>00</b>	+ 242,20	+ 242,20	+ 242,20
Black	<b>08</b>	+ 242,20	+ 242,20	+ 242,20

**MANDATORY COMPLEMENT FOR TRANSPARENT GLASS TOP SURFACE**

Trim container	<b>XT</b>	+ 50,40	+ 50,40	+ 50,40
----------------	-----------	---------	---------	---------

**Electrical accessories**

Meeting desks

					
<b>COMPONENTS</b>	Extension cable (1'5 m.)	End power entry 2 mts. EU · 220V	End power entry 2 mts. UK · 220V	End power entry 2 mts. US · 120V	Connection spread kit.
<b>DESCRIPTION</b>	Ø 10 mm. (3 x 2'5). Rubber hose Male and female connector to connect additional power module.	Ø 8 mm. (3 x 2). Rubber hose Plug and ground Ø 4'8 / 16A Female terminal plugged (with protection).			1 input / 3 outputs
<b>MINIMUM UNITS ORDER</b>	4 units · Price for 1 unit	4 units · Price for 1 unit	4 units · Price for 1 unit	4 units · Price for 1 unit	5 units · Price for 1 unit
<b>REFERENCE</b>	<b>GX20</b>	<b>GX21</b>	<b>GX21L</b>	<b>GX21D</b>	<b>GX22</b>
<b>PRICE</b>	37,80	40,60	40,60	40,60	26,60

Explanation of use of the cable tray - desks de reunión

Use of cable tray on Meeting desks of 120 cm:

To use electrification cable tray on desks of 120 cm width, request the desired/corresponding model, which is listed on the pricelist:

- 40 cm Channel for individual use 160, 220, 320 and 160(progressive) cm desks.
- 111,5 cm Channel for individual use 220cm desks.



AK1G011612C



AK1G012212C



AK1G013212C





AK1G021612C



AK1G012212C

Simple Cable tray  
Individual desks

		
Measures	400 x 175 mm	1115 x 181 mm
Compatibility	1600 / 2200 / 3200 / 1600 mm desks	2200 mm desks
Packs	Pack 1 unit	Pack 1 unit
Reference	<b>XAKTC1A10417</b>	<b>XAKTC1A51118</b>

TYPE OF ANCHOR			
Fixed	<b>A</b>	46,20	88,20

SURFACE FINISH			
Steel · White	<b>C00</b>		
Steel · Black	<b>C08</b>		

Use of cable tray on Meeting desks of 140 cm:

To use electrification cable tray on desks of 140 cm width, request the desired/corresponding model, which is listed on the pricelist::

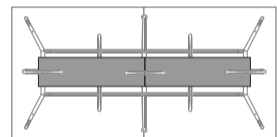
- 44cm width Recessed Cable tray: Use on AK1G011414C meeting desk - Length 116 cm.
- 44cm width Recessed Cable tray: Use on AK1G012814C meeting desk - Length 122 cm.
- 44cm width Recessed Cable tray: Use on AK1G021414C meeting desk - Length 139 cm.

**XAKTC1B51142**



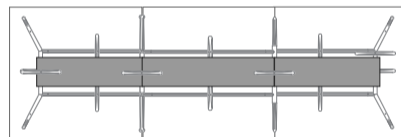
AK1G011414C

**XAKTC1B51242 XAKTC1B51242**



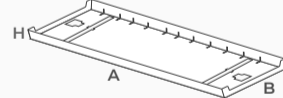
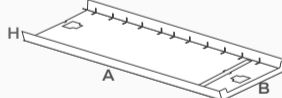
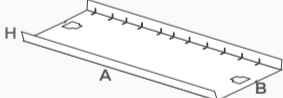
AK1G012814C

**XAKTC1B51242 XAKTC1C51442 XAKTC1B51242**



AK1G012814C + AK1G021414C

Cable tray  
Meeting tables · 1400 mm wide

			
Measures	1160 x 440 mm	1228 x 440 mm	1399 x 440 mm
Compatibility	1400 x 1400 mm desks	2800 x 1400 mm desks	1400 x 1400 mm progression desks
Packs	Pack 1 unit	Pack 2 unit	Pack 1 unit
Reference	<b>XAKTC1B51142</b>	<b>XAKTC1B51242</b>	<b>XAKTC1C51442</b>

TYPE OF ANCHOR			
Fixed	<b>A</b>	197,40	330,40
			163,80

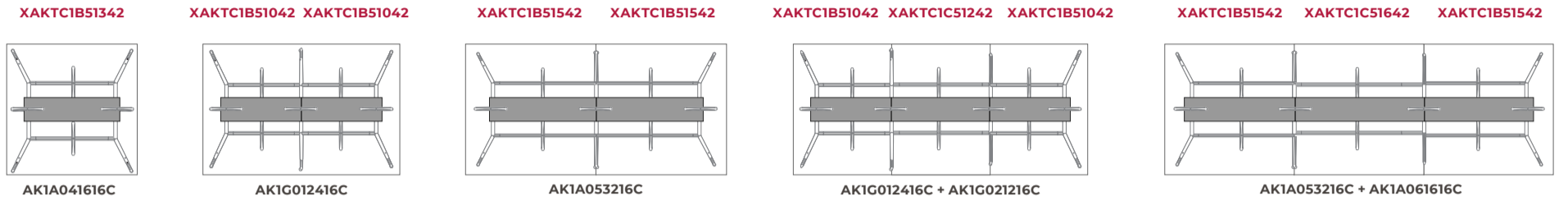
SURFACE FINISH			
Steel · White	<b>C00</b>		
Steel · Black	<b>C08</b>		

EXPLANATION OF USE OF THE CABLE TRAY - DOUBLE OPERATIVE DESKS, EXTENDABLE DOUBLE DESKS AND MEETING DESKS

Use of cable tray on **double operative desks, extendable double desks and meeting desks of 160 cm:**

To use electrification cable tray on desks of 160 cm width, request the desired/corresponding model, which is listed on the pricelist::

- 44cm width Recessed Cable tray: Use on AK1G011414C - 136 cm length.
- 44cm width Recessed Cable tray: Use on AK1G012416C - 102 cm length.
- 44cm width Recessed Cable tray: Use on AK1A053216C - 144 cm length.
- 44cm width Recessed Cable tray: Use on AK1G021216C - 119 cm length.
- 44cm width Recessed Cable tray: Use on AK1A061616C - 159 cm length.



**Telecanal double**

Double & meeting tables · Width 1600 mm

<b>Measures</b>	1360 x 440 mm	1028 x 440 mm	1428 x 440 mm	1199 x 440 mm	1599 x 440 mm
<b>Compatibility</b>	1600 x 1600 mm desks	2400 x 1600 mm desks	3200 x 1600 mm desks	1200 x 1600 mm desks	1600 x 1600 mm desks
<b>Packs</b>	Pack 1 unit	Pack 2 units	Pack 2 units	Pack 1 unit	Pack 1 unit
<b>Reference</b>	<b>XAKTC1B51342</b>	<b>XAKTC1B51042</b>	<b>XAKTC1B51542</b>	<b>XAKTC1C51242</b>	<b>XAKTC1C51642</b>

TYPE OF ANCHOR

Fixed	<b>A</b>	207,20	317,80	343,00	155,40	170,80
-------	----------	--------	--------	--------	--------	--------

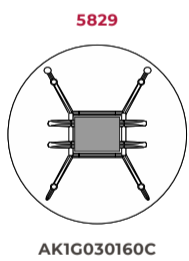
SURFACE FINISH

Steel · White	<b>C00</b>					
Steel · Black	<b>C08</b>					

Use of cable tray on **meeting tables round diameter 160 cm:**

To use electrification cable tray on desks of 160 cm diameter, request the desired/corresponding model, which is listed on the pricelist:

- 42cm width Recessed Cable tray: Use on AK1G030160C - 160 cm diameter.



**Cable tray**

160 cm diameter desks

<b>MEASURES</b>	500 x 420 x 30,8 mm
<b>COMPATIBILITY</b>	For use on <b>AK1G030160C</b>
<b>REFERENCE</b>	<b>5829</b>

STRUCTURE

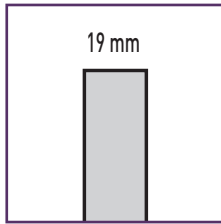
White	<b>0</b>	70,00
Black	<b>8</b>	



■ **Desks mounted screens**

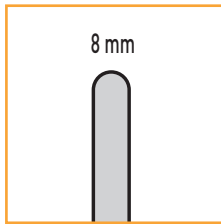
Desk-Mounted screens, different sizes available, fixing kits and finishes. Easy to be adapted to any surface. They provide visual contact but at the same time privacy. Twin desks with electrification system have their own desk-mounted screens (**D50 Serie for Vital or Arkitek**)

■ **DESK MOUNTED SCREENS OFFER**



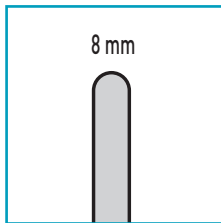
**MFC SCREEN - e=19mm**

19 mm thick Chipboard



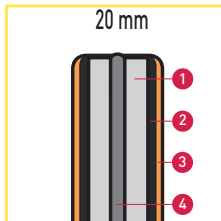
**GLASS SCREEN - e=8mm**

Laminated Security Glass (4+4 mm) / Tempered glass (8 mm)



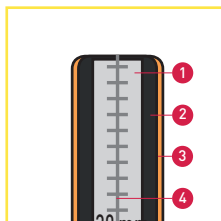
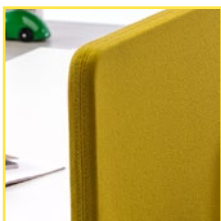
**METHACRYLATE SCREEN - e=8mm**

8 mm thick White Methacrylate



**UPHOLSTERED SCREEN WITH FLEXIBLE PROFILE - e=30mm**

- ① 19 mm thick Chipboard
- ② Foam thickness e= 5 mm and 60 Kg/m<sup>3</sup> density (etotal= 30 mm)
- ③ Different fabrics available glued using water glue.  
- Optional acoustic or fire resistant fabrics for projects.
- ④ 8mm thick flexible Profile



**UPHOLSTERED SCREEN. SEWED AND SHEATHED - e=30mm**

- ① 19 mm thick Chipboard
- ② Foam thickness e= 5 mm and 60 Kg/m<sup>3</sup> density (etotal= 30 mm)
- ③ Different fabrics available glued using water glue.  
- Optional acoustic or fire resistant fabrics for projects.
- ④ Sewn and sheathed.

**EXAMPLE OF AN ORDER**

Model	Bracket finish	Divider Finish	Final Reference
<b>DLN432</b> Screen mobile Pack 2 units	<b>N</b> Black bracket	<b>T82</b> Group T Upholstered	<b>DLN432NT82</b>

**TABLE TOP DIVIDERS - SUPPORT ON DISCS**

Support on discs with anti slip pad.

**Upholstered divider e=30 mm**

**Upholstered divider e=30 mm**

Model Dimensions (A x B)	<b>ZW43</b>	<b>ZW44</b>	<b>ZW45</b>
	110 38	130 38	150 38
	<b>TABLE TOP DIVIDER FOR 120, 140 and 160 cm DESK</b>	<b>TABLE TOP DIVIDER FOR 140 and 160 cm DESK</b>	<b>TABLE TOP DIVIDER FOR 160 cm DESK</b>

Coding required to configure reference.  
They do not mean an increase in cost

Units / Pack		Pack 1 Unit	Pack 2 Units	Pack 1 Unit	Pack 2 Units	Pack 1 Unit	Pack 2 Units
Base Reference		<b>ZW431</b>	<b>ZW432</b>	<b>ZW441</b>	<b>ZW442</b>	<b>ZW451</b>	<b>ZW452</b>
Bracket finish	WHITE	0					
	BLACK	8					

**FLEXIBLE PROFILE UPHOLSTERED DIVIDER e= 30 mm - h= 38 cm**

Upholstered e=30 Flexible profile	GROUP 0	Group T	<b>3T--</b>	180,60	344,40	186,20	358,40	198,80	386,40
	GROUP 1	Group AE	<b>3AE--</b>	207,20	397,60	218,40	422,80	259,00	506,80
Group AO		<b>3AO--</b>							
GROUP 2	Group D	<b>3D--</b>	217,00	425,60	232,40	450,80	287,00	558,60	
	Group M	<b>3M--</b>							

Model Dimensions (A x B)	<b>DLN43</b>	<b>DLN44</b>	<b>DLN45</b>
	110 38	130 38	150 38
	<b>TABLE TOP DIVIDER FOR 140 and 160 cm DESK</b>	<b>TABLE TOP DIVIDER FOR 140 and 160 cm DESK</b>	<b>TABLE TOP DIVIDER FOR 160 cm DESK</b>

Units / Pack		Pack 1 Unit	Pack 2 Units	Pack 1 Unit	Pack 2 Units	Pack 1 Unit	Pack 2 Units
Base Reference		<b>DLN431</b>	<b>DLN432</b>	<b>DLN441</b>	<b>DLN442</b>	<b>DLN451</b>	<b>DLN452</b>
Bracket finish	WHITE	<b>B</b>					
	BLACK	<b>N</b>					

**SEWN AND SHEATHED UPHOLSTERED DIVIDER e= 30 mm - h= 38 cm**

Upholstered e=30 Sewn and sheathed	GROUP 0	Group T	<b>T--</b>	212,80	414,40	218,40	428,40	235,20	456,40
	GROUP 1	Group AE	<b>AE--</b>	239,40	467,60	253,40	498,40	294,00	574,00
Group AO		<b>AO--</b>							
GROUP 2	Group D	<b>D--</b>	252,00	494,20	267,40	522,20	320,60	628,60	
	Group M	<b>M--</b>							
GROUP 3	Group A	<b>A--</b>	298,20	585,20	319,20	625,80	380,80	749,00	

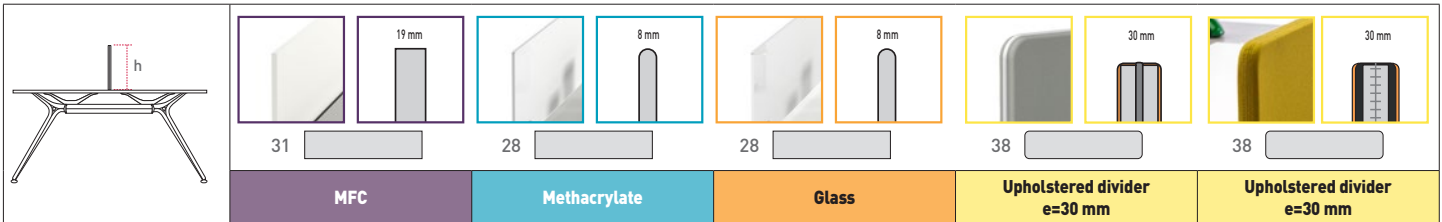


**EXAMPLE OF AN ORDER**

Model	Bracket finish	Divider Finish	Final Reference
<b>ZK232</b> Screen for frontal use Pack 2 units	<b>0</b> White bracket	<b>3T82</b> Group T Upholstered	<b>ZK23203T82</b>

Coding required to configure reference.  
They do not mean an increase in cost

**TABLE TOP DIVIDERS FOR - FRONTAL USE ON DOUBLE DESKS**



Model Dimensions (A x B)		ZK23 110	ZK24 130	ZK25 150					
		FOR 140, 160 and 180 cm DESK	FOR 140, 160 and 180 cm DESK	FOR 160 and 180 cm DESK					
Units / Pack		Pack 1 Unit	Pack 2 Units.	Pack 1 Unit	Pack 2 Units.	Pack 1 Unit	Pack 2 Units.		
Base Reference		ZK231	ZK232	ZK241	ZK242	ZK251	ZK252		
Bracket finish	WHITE	0							
<b>MFC DIVIDER e = 19 mm - h = 31 cm</b>									
MFC	White	00	78,40	147,00	81,20	152,60	86,80	162,40	
	Black	08	78,40	147,00	81,20	152,60	86,80	162,40	
<b>METHACRYLATE DIVIDER e = 8 mm - h = 28 cm</b>									
Methacrylate	White	90	147,00	280,00	158,20	303,80	169,40	326,20	
<b>GLASS DIVIDER e = 8 mm - h = 28 cm</b>									
Glass	White	52	261,80	508,20	288,40	562,80	316,40	618,80	
<b>FLEXIBLE PROFILE UPHOLSTERED DIVIDER e= 30 mm - h= 38 cm</b>									
Upholstered e= 30 Flexible profile	GROUP 0	Group T	3T--	156,80	301,00	163,80	313,60	177,80	341,60
	GROUP 1	Group AE	3AE--	183,40	354,20	196,00	378,00	238,00	462,00
		Group AO	3AO--						
	GROUP 2	Group D	3D--	196,00	380,80	210,00	408,80	264,60	513,80
		Group M	3M--						
<b>SEWN AND SHEATHED UPHOLSTERED DIVIDER e= 30 mm - h= 38 cm</b>									
Upholstered e= 30 Sewn and sheathed	GROUP 0	Group T	T--	190,40	371,00	197,40	383,60	211,40	411,60
	GROUP 1	Group AE	AE--	217,00	424,20	232,40	453,60	270,20	529,20
		Group AO	AO--						
	GROUP 2	Group D	D--	231,00	446,60	245,00	477,40	298,20	585,20
		Group M	M--						
	GROUP 3	Group A	A--	275,80	539,00	296,80	581,00	357,00	702,80