

Prices shown are not the final selling price.
To obtain the list price, multiply the price by 2.65.
Prices effective as February 2024.

LONGO

— By Ramos&Bassols —



Desks and separate storage units

Straight desks · Width 800 mm

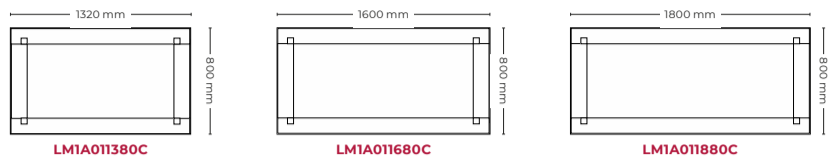

Contract desks

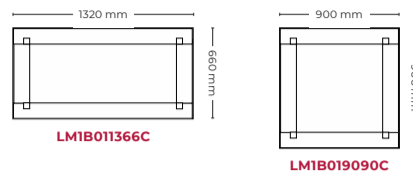

Twin, bench and progressive desks · Width 1600 mm

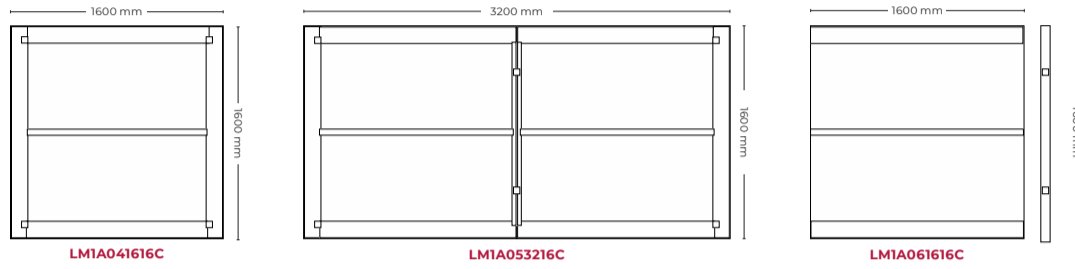

Meeting tables · Width 1000 mm

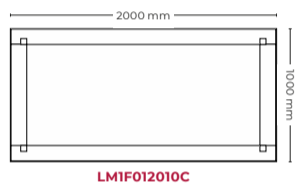

Tables with file support · Width 800 mm · Reversible auxiliary Cabinet

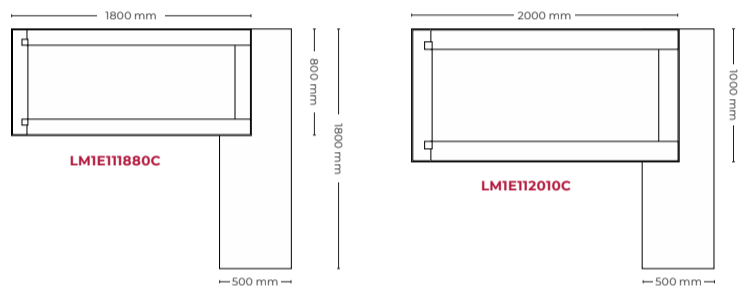

Meeting tables · Width 1200 mm

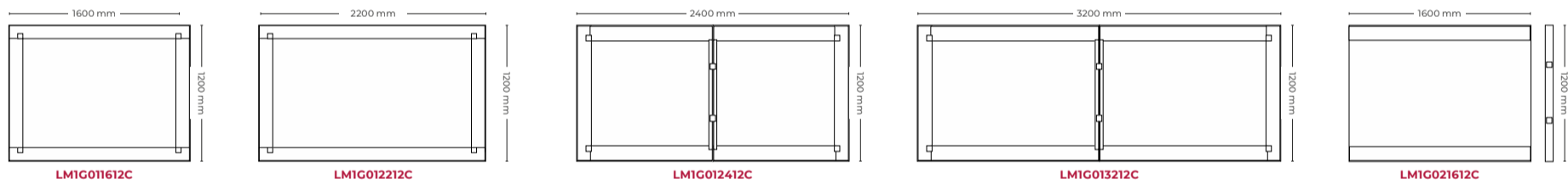

Meeting tables · Width 1320 mm

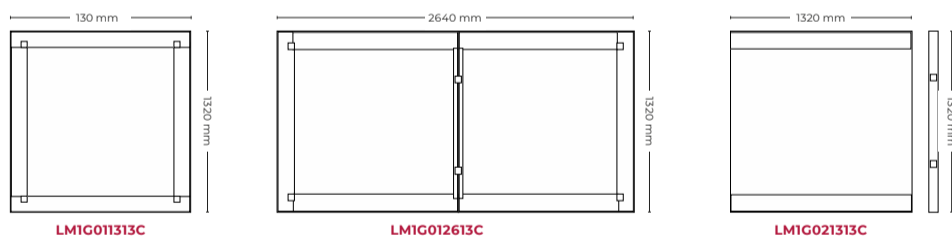

Meeting tables · Width 1600 mm

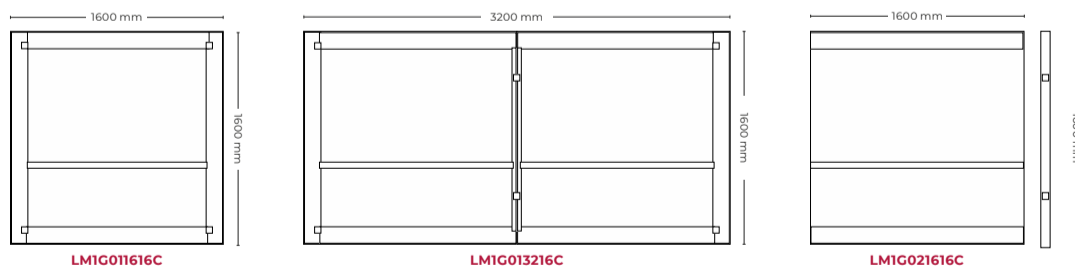

Surface finishes

Melamine · 19 mm



Tempered glass · 10 mm

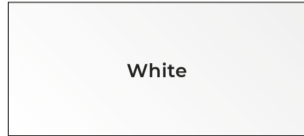

Laminated safety glass · 5 + 5 mm

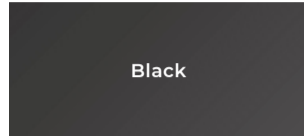

Structural finishes

Structure, legs and brackets are all offered in the following finishes:



Frame: White

Feet: White

Frame: Black

Feet: Black

Frame: Black

Feet: Polished

Accessories

Electrification system

An integrated electrification system which enables effective management of cabling and easy installation. It has a steel tray with a large capacity which sits under the work surfaces, which is accessed by via an aluminium door supported on a central beam.



Metal tray made from 1mm sheet steel, great capacity for wires and connections for twin desks. Maximum accessibility optimizing the work surface, enables optimal wiring management. Two models available

- Fixed height
- Height regulation (three positions)



Polystyrene tray for individual or twin desks with wiring and connections. Maximum accessibility optimizing the work surface enabling optimal wiring management. It is anchored directly to the beams of the Longo structure.



Output wiring and connections, allow quick and easy access to the connections and wiring from the surface of the tables.

Optional accessories

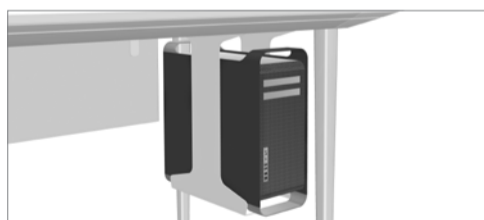

CPU holder. 25-30x49 cm and 1,5 mm thick sheet steel







Modesty panel

Desktop screen

Longo has its own system of desktop screens which are anchored directly onto the surface of the table, giving great stability and aesthetic appeal. Fully upholstered, with aluminum profile or rail guides for fixing 3rd level items, soundproof and glass composition, the new desktop screens offer many possibilities. Longo also has movable desktop screens incorporating a stable support system without fixation, which allows the user to change the position of the screen according to their needs at any moment.



How to code a reference

			
T Wiring Access	Q Wiring Access	R Wiring Access	P Wiring Access
Maximum opening: 90°	Maximum opening: 110°	Maximum opening: 180°	Maximum opening: 180°
<ul style="list-style-type: none"> • ABS injected lid • Frame injected in ABS • Injection-moulded polyamide clamping clips PA • Black bristle brush with zinc-plated plate profile • Polyamide guides for adjustment according to the thickness of the surface between 13 and 30 mm • Dimensions: 25 x 11,7 cm 	<ul style="list-style-type: none"> • Black die-cast aluminium frame • Die-cast aluminium lid • Aluminium guides for adjustment according to the thickness of the surface between 13 and 30 mm • Dimensions: 30,5 x 12,1 cm 	<ul style="list-style-type: none"> • Melamine lid of the same finish as the surface • Black Bristle Brush • Black die-cast aluminium frame • Aluminium guides for adjustment according to the thickness of the surface between 13 and 30 mm • Complete opening in 180° by means of hinges. • Dimensions: 30,5 x 12,1 cm 	<ul style="list-style-type: none"> • The wiring access P only includes the cut-out in the table top. • If you order the desking with the optional PC wiring access, please refer to the accessories section to order the integrated power and data connection in the desk top. • Compact solution for integrated power and data connection with easy workstation access. • Different configuration combinations for a wide range of applications. • Perimeter frame in black aluminium. • Optional integrated aluminium cover to protect connections against dust and dirt. Available in black and white. • Total dimensions: 241 x 73 mm • Total dimensions cover: 257 x 87 mm • Junction box top surface dimensions: 225 x 60 mm

-Models with this standard cable access has the icon next to the code
 -Desk price with the cable access is as per the attached table.
 -To order different desks which the electrification access is not standard, please check sales team.
 -To order desks with cable access, please add the corresponding letter according to the desired placement, at the end of the reference:

WIRING ACCESS

	FRONT CENTERED ACCESS	LEFT HAND SIDE	RIGHT HAND SIDE	CENTERED ACCESS
	TF QF RF	TL QL RL	TR QR RR	PC QC RC

IMPORTANT NOTE:

The combination of wired access is carried out in the following way:
 (If in any case you want the upper access in different finishing established, the customer must indicate it on the order.)

MELAMINE SURFACE FINISHES AND STRUCTURE		COMBINATIONS OF FINISHES OFFERED			
Surface	Structure	T WIRING ACCES	Q WIRING ACCES	R WIRING ACCES	P WIRING ACCES
WHITE	WHITE	WHITE	WHITE	WHITE	WHITE
	BLACK	WHITE	WHITE	WHITE	WHITE
	POLISHED	WHITE	WHITE	WHITE	WHITE
LIME OAK	WHITE	WHITE	WHITE	LIME OAK	WHITE
	BLACK	BLACK	BLACK	LIME OAK	BLACK
	POLISHED	BLACK	BLACK	LIME OAK	BLACK
LIGHT OAK	WHITE	WHITE	WHITE	LIGHT OAK	WHITE
	BLACK	BLACK	BLACK	LIGHT OAK	BLACK
	POLISHED	BLACK	BLACK	LIGHT OAK	BLACK
CHESTNUT	WHITE	WHITE	WHITE	CHESTNUT	WHITE
	BLACK	BLACK	BLACK	CHESTNUT	BLACK
	POLISHED	BLACK	BLACK	CHESTNUT	BLACK
DARK OAK	WHITE	WHITE	WHITE	DARK OAK	WHITE
	BLACK	BLACK	BLACK	DARK OAK	BLACK
	POLISHED	BLACK	BLACK	DARK OAK	BLACK
BLACK	WHITE	BLACK	BLACK		BLACK
	BLACK	BLACK	BLACK		BLACK
	POLISHED	BLACK	BLACK		BLACK

Superior cable access location to cabling and connections

Rectangular desks - 80 cm wide

Front access

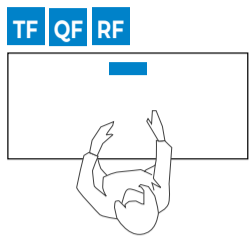

Right lateral access

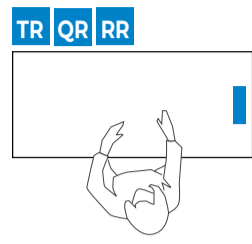

Left lateral access

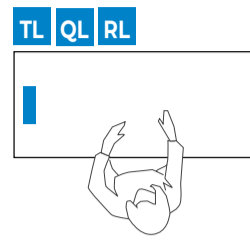

Twin and progressive desks - 160 cm wide

Front access

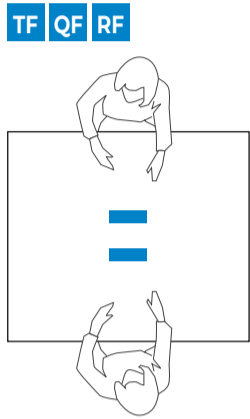

Front access

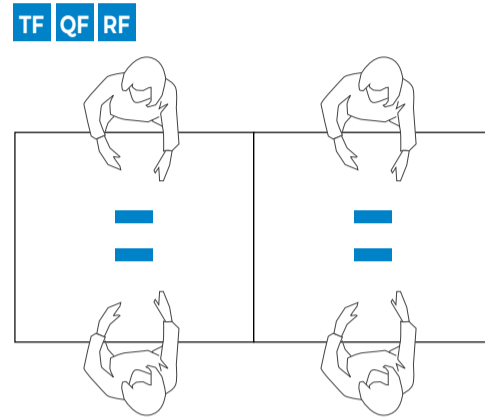

Front access

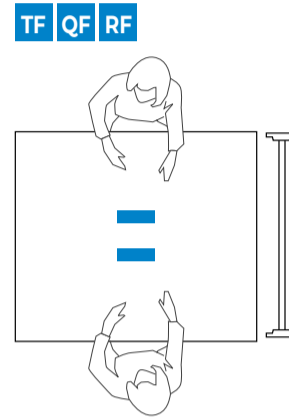

Executive and meeting desks - 100 cm wide

Front access

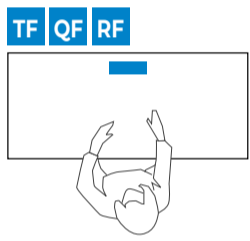

Right lateral access

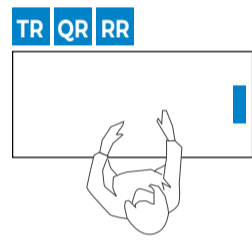

Left lateral access

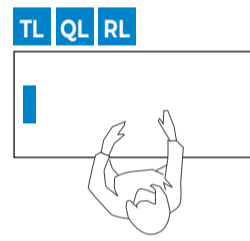

Centered access

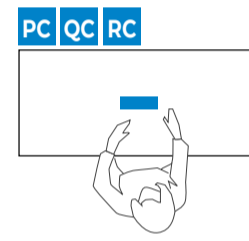

Meeting desks - 120 / 132 / 160 cm wide

Centered access

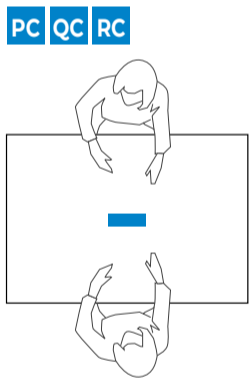

Centered access

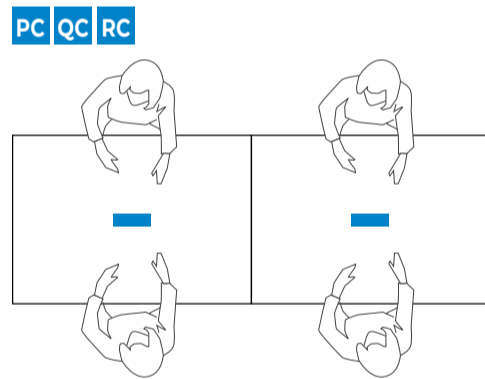

Centered access

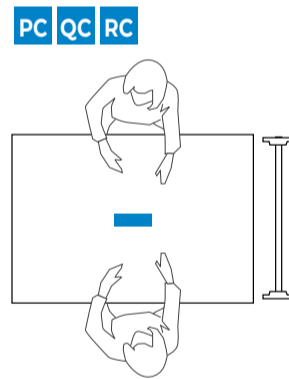

Program of tables

Individual operating tables · Width 800 mm

Contract desks

TF TR TL QF QR QL
RF RR RL

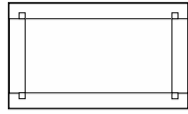

LM1A011380C

TF TR TL QF QR QL
RF RR RL

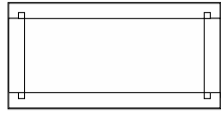

LM1A011680C

TF TR TL QF QR QL
RF RR RL

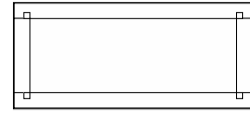

LM1A011880C



LM1B011366C

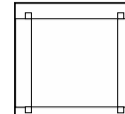

LM1B019090C

Double & Progression tables · Wide 1600 mm

TF QF RF

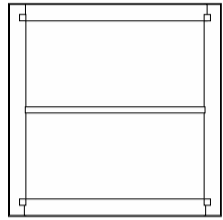

LM1A041616C

TF QF RF

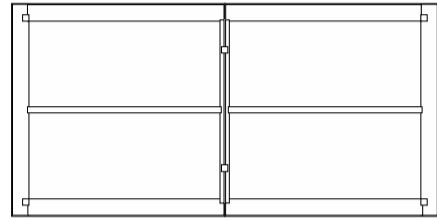

LM1A053216C

TF QF RF

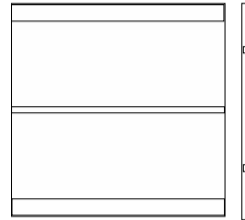

LM1A061616C

Meeting tables · Width 1000 mm

Tables with file support · Width 800/1000 mm

TF TR TL PC
QF QR QL QC RF RR RL RC



LM1F012010C

TF TR QF QR RF RR

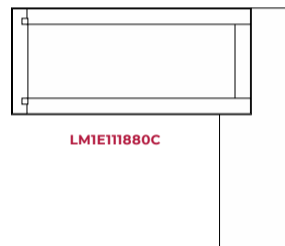

LM1E111880C

TF TR QF QR RF RR

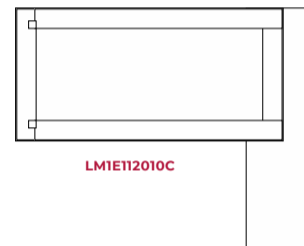

LM1E12010C

Meeting tables · Width 1200 mm

PC QC RC

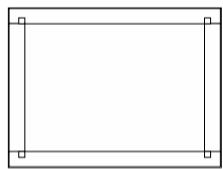

LM1G011612C

PC QC RC



LM1G012212C

PC QC RC

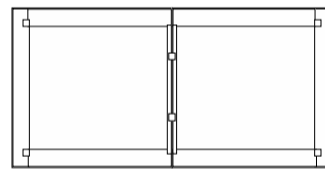

LM1G012412C

PC QC RC

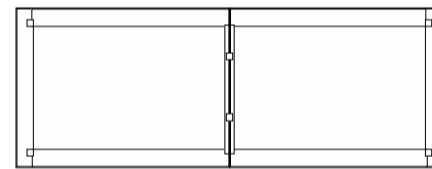

LM1G013212C

PC QC RC

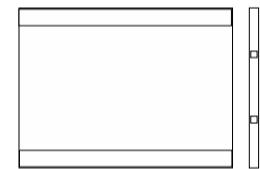

LM1G021612C

Meeting tables · Width 1320 mm

PC QC RC

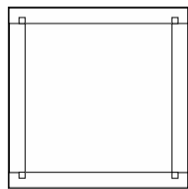

LM1G011313C

PC QC RC

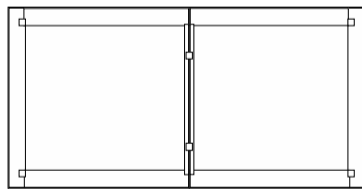

LM1G012613C

PC QC RC

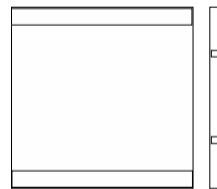

LM1G021313C

Meeting tables · Width 1600 mm

PC QC RC

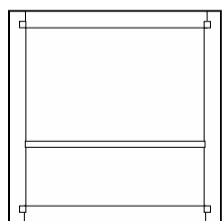

LM1G011616C

PC QC RC

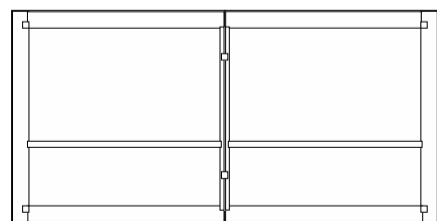

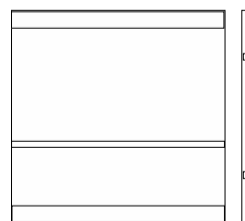

LM1G013216C

PC QC RC



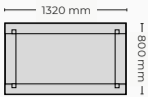

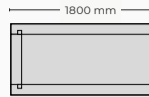





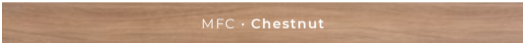

LM1G021616C

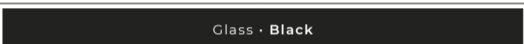
Straight desks Width 800 mm				
	MEASURES	1320 x 800 mm	1600 x 800 mm	1800 x 800 mm
	HEIGHT	Height 740 mm	Height 740 mm	Height 740 mm
	REFERENCE	LM1A011380C	LM1A011680C	LM1A011880C

STRUCTURE				
Straight legs	B	772,80	814,80	845,60

SUPPORT				
Levelers	F			
Height adjustment system	C	+ 214,20	+ 214,20	+ 214,20

FINISHES SURFACE				
	M00			
	M11			
	M10			
	M07			
	M14			
	M03	+ 154,00	+ 180,60	+ 180,60
	V59	+ 469,00	+ 547,40	+ 581,00
	V52	+ 469,00	+ 547,40	+ 581,00

FINISHES STRUCTURE					
Frame	Legs	Ref	↓	↓	↓
		00			
		08			
		09	+ 306,60	+ 306,60	+ 306,60



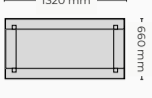
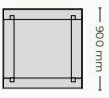

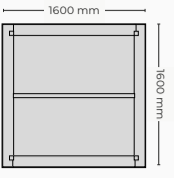
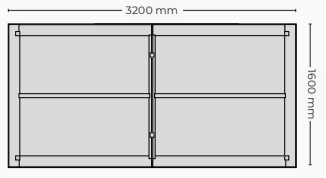
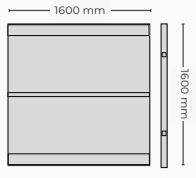

OPTIONAL WIRING ACCESS				
MFC	TF			
	TL	+ 36,40	+ 36,40	+ 36,40
	TR			
	QF			
	QL	+ 72,80	+ 72,80	+ 72,80
	QR			
	RF			
	RL	+ 95,20	+ 95,20	+ 95,20
MFC BLACK ANTI-FINGERPRINT	TF			
	TL	+ 36,40	+ 36,40	+ 36,40
	TR			
	QF			
	QL	+ 72,80	+ 72,80	+ 72,80
	QR			



Contract desks Width 660/900 mm					
MEASURES		1320 x 660 mm		900 x 900 mm	
HEIGHT		Height 740 mm		Height 740 mm	
REFERENCE		LM1B011366C		LM1B019090C	
STRUCTURE					
Straight legs		B	704,20	684,60	
SUPPORT					
Levelers		F			
Height adjustment system		C	+ 214,20	+ 214,20	
FINISHES SURFACE					
MFC · White		M00			
MFC · Lime Oak		M11			
MFC · Light Oak		M10			
MFC · Chestnut		M07			
MFC · Dark Oak		M14			
MFC · Black anti-fingerprint		M03	+ 154,00	+ 133,00	
Glass · Black		V59	+ 397,60	+ 351,40	
Glass · White		V52	+ 397,60	+ 351,40	
FINISHES STRUCTURE					
Frame	Legs	Ref	↓	↓	
White		00			
Black		08			
Black	Polished	09	+ 306,60	+ 306,60	

Double desks and middle extensions Width 1600 mm			
			
MEASURES	1600 x 1600 mm	3200 x 1600 mm	1600 x 1600 mm · Extension desk
HEIGHT	Height 740 mm	Height 740 mm	Height 740 mm
REFERENCE	LM1A041616C	LM1A053216C	LM1A061616C

STRUCTURE				
Straight legs	B	1.027,60	1.727,60	880,60

SUPPORT				
Levelers	F			
Height adjustment system	C	+ 214,20	+ 320,60	+ 107,80

FINISHES SURFACE				
	M00			
	M11			
	M10			
	M07			
	M14			
	M03	+ 637,00	+ 1.274,00	+ 637,00

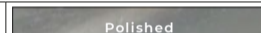





FINISHES STRUCTURE					
Frame	Legs	Ref	↓	↓	↓
		00			
		08			
		09	+ 306,60	+ 450,80	+ 151,20





OPTIONAL WIRING ACCESS				
MFC	TF	+ 72,80	+ 145,60	+ 72,80
	QF	+ 145,60	+ 291,20	+ 145,60
	RF	+ 190,40	+ 380,80	+ 190,40
MFC BLACK ANTI-FINGERPRINT	TF	+ 72,80	+ 145,60	+ 72,80
	QF	+ 145,60	+ 291,20	+ 145,60

Executive desks and meeting table Width 1000 mm	
MEASURES	2000 x 1000 mm
HEIGHT	Height 740 mm
REFERENCE	LMIF012010C

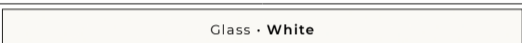
STRUCTURE		
Straight legs	B	932,40

SUPPORT		
Levelers	F	
Height adjustment system	C	+ 214,20

FINISHES SURFACE		
	M00	
	M11	
	M10	
	M07	
	M14	
	M03	+ 267,40
	V59	+ 775,60
	V52	+ 775,60

FINISHES STRUCTURE			
Frame	Legs	Ref	↓
		00	
		08	
		09	+ 306,60

OPTIONAL WIRING ACCESS		
MFC	PC	+ 30,80
	TF	
	TR	+ 36,40
	TL	
	QF	
	QR	
	QL	+ 72,80
	QC	
	RF	
	RR	
	RL	+ 95,20
	RC	
MFC BLACK ANTI-FINGERPRINT	PC	+ 30,80
	TF	
	TR	+ 36,40
	TL	
	QF	
	QR	
	QL	+ 72,80
	QC	
GLASS	PC	+ 231,00

	<p>IMPORTANT NOTE:</p> <p>When ordering the table with the optional PC wiring access, please refer to the accessories section to order the power and data connection integrated in the table top. The optional PC wiring access only includes the cut-out in the table top.</p>
---	--

IMPORTANT NOTE:
THE DESKS WITH CABINET SUPPORT MUST **ALWAYS BE ORDERED WITH THE STORAGE UNIT.**
TWO ORDERS MUST BE DONE: THE TABLE ORDER + THE STORAGE UNIT ORDER

Desk with cabinet support - executive
Width 800/1000 mm

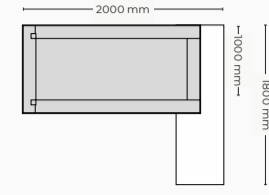
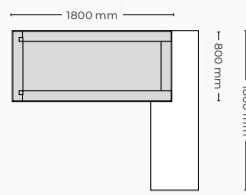

MEASURES	1800 x 800 mm · Reversible	2000 x 1000 mm · Reversible
HEIGHT	Height 740 mm	Height 740 mm
REFERENCE	LM1E11880C	LM1E112010C

STRUCTURE

Straight legs	B	701,40	774,20
---------------	----------	--------	--------

SUPPORT

Levelers	F		
----------	----------	--	--

FINISHES SURFACE

MFC · White	M00		
MFC · Lime Oak	M11		
MFC · Light Oak	M10		
MFC · Chestnut	M07		
MFC · Dark Oak	M14		
MFC · Black anti-fingerprint	M03	+ 180,60	+ 267,40
Glass · Black	V59	+ 581,00	+ 775,60
Glass · White	V52	+ 581,00	+ 775,60

FINISHES STRUCTURE

Frame	Legs	Ref	↓	↓
White		00		
Black		08		
Black	Polished	09	+ 151,20	+ 151,20

OPTIONAL WIRING ACCESS

MFC	TF	+ 36,40	+ 36,40	
	TR			
	QF	+ 72,80	+ 72,80	
	QR			
		RF	+ 95,20	+ 95,20
		RR		
MFC BLACK ANTI-FINGERPRINT	TF	+ 36,40	+ 36,40	
	TR			
	QF	+ 72,80	+ 72,80	
	QR			

IMPORTANT NOTE:
THE DESKS WITH CABINET SUPPORT MUST **ALWAYS BE ORDERED WITH THE STORAGE UNIT.**
TWO ORDERS MUST BE DONE: THE TABLE ORDER + THE STORAGE UNIT ORDER

Storage unit for desk with cabinet support
Height 690 mm

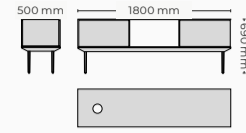

MODEL	Longo storage unit · Model 3 holes for desk with cabinet support
MEASURES	1800 x 500 x 690 mm
REFERENCE	LMM11807

STRUCTURE			
Frame	Legs	Ref	
White		00	1.205,40
Black		08	
Black	Polished	09	61,60

FINISHES SURFACE			
Body and top surface	Doors	Ref	
MFC · White	Glass · White	M00V52	+ 79,80
	Glass · Black	M00V59	
MFC · Lime Oak	Glass · White	M11V52	
	Glass · Black	M11V59	
MFC · Light Oak	Glass · White	M10V52	
	Glass · Black	M10V59	
MFC · Chestnut	Glass · White	M07V52	
	Glass · Black	M07V59	
MFC · Dark Oak	Glass · Black	M14V59	
MFC · Black anti-fingerprint	Glass · Black	M03V59	

OBLIGATED WIRING ACCESS		
MFC	UF	

Optional drawer
Complement for storage units

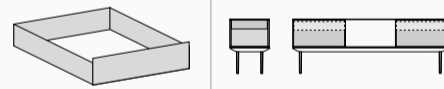

MODEL	Frontal MFC Drawer and Metal Structure
COMPATIBILITY	For Longo storage LMM11807
REFERENCE	LMM191807

FINISHES SURFACE		
MFC · White	M00	155,40
MFC · Lime Oak	M11	
MFC · Light Oak	M10	
MFC · Chestnut	M07	
MFC · Dark Oak	M14	

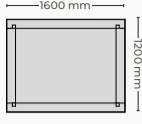
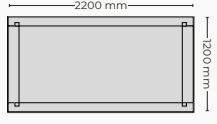
Meeting desks Width 1200 mm			
MEASURES		1600 x 1200 mm	2200 x 1200 mm
HEIGHT		Height 740 mm	Height 740 mm
REFERENCE		LM1G011612C	LM1G012212C
STRUCTURE			
Straight legs	B	925,40	1.019,20
SUPPORT			
Levelers	F		
Height adjustment system	C	+ 214,20	+ 214,20
FINISHES SURFACE			
MFC · White	M00		
MFC · Lime Oak	M11		
MFC · Light Oak	M10		
MFC · Chestnut	M07		
MFC · Dark Oak	M14		
MFC · Black anti-fingerprint	M03	+ 271,60	+ 603,40
Glass · Black	V59	+ 889,00	+ 1.687,00
Glass · White	V52	+ 889,00	+ 1.687,00
FINISHES STRUCTURE			
Frame	Legs	Ref	↓
White		00	
Black		08	
Black	Polished	09	+ 306,60
OPTIONAL WIRING ACCESS			
MFC	PC	+ 30,80	+ 30,80
	QC	+ 72,80	+ 72,80
	RC	+ 95,20	+ 95,20
MFC BLACK ANTI-FINGERPRINT	PC	+ 30,80	+ 30,80
	QC	+ 72,80	+ 72,80
GLASS	PC	+ 231,00	+ 231,00



IMPORTANT NOTE:
When ordering the table with the optional **PC wiring access**, please refer to the accessories section to order the power and data connection integrated in the table top. The optional **PC wiring access** only includes the cut-out in the table top.

Meeting desks and extension desk Width 1200 mm				
	MEASURES	2400 x 1200 mm	3200 x 1200 mm	1600 x 1200 mm · Extension desk
	HEIGHT	Height 740 mm	Height 740 mm	Height 740 mm
	REFERENCE	LMIG012412C	LMIG013212C	LMIG021612C

STRUCTURE				
Straight legs	B	1.138,20	1.517,60	750,40

SUPPORT				
Levelers	F			
Height adjustment system	C	+ 320,60	+ 320,60	+ 107,80

FINISHES SURFACE				
	M00			
	M11			
	M10			
	M07			
	M14			
	M03	+ 462,00	+ 543,20	+ 271,60
	V59	+ 1.386,00	+ 1.528,80	+ 833,00
	V52	+ 1.386,00	+ 1.528,80	+ 833,00

FINISHES STRUCTURE					
Frame	Legs	Ref	↓	↓	↓
		00			
		08			
		09	+ 450,80	+ 450,80	+ 151,20





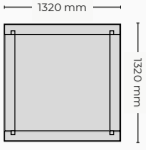
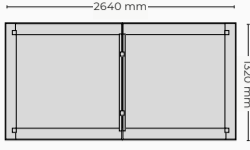
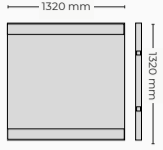

OPTIONAL WIRING ACCESS				
MFC	PC	+ 61,60	+ 61,60	+ 30,80
	QC	+ 145,60	+ 145,60	+ 72,80
	RC	+ 190,40	+ 190,40	+ 95,20
MFC BLACK ANTI-FINGERPRINT	PC	+ 61,60	+ 61,60	+ 30,80
	QC	+ 145,60	+ 145,60	+ 72,80
GLASS	PC	+ 462,00	+ 462,00	+ 231,00





	<p>IMPORTANT NOTE: When ordering the table with the optional PC wiring access, please refer to the accessories section to order the power and data connection integrated in the table top. The optional PC wiring access only includes the cut-out in the table top.</p>
--	---

Meeting desks Width 1320 mm				
	MEASURES	1320 x 1320 mm	2640 x 1320 mm	1320 x 1320 mm · Extension desk
	HEIGHT	Height 740 mm	Height 740 mm	Height 740 mm
	REFERENCE	LMIG011313C	LMIG012613C	LMIG021313C

STRUCTURE				
Straight legs	B	849,80	1.499,40	666,40

SUPPORT				
Levelers	F			
Height adjustment system	C	+ 214,20	+ 320,60	+ 107,80

FINISHES SURFACE				
	M00			
	M11			
	M10			
	M07			
	M14			
	M03	+ 246,40	+ 492,80	+ 246,40

FINISHES STRUCTURE					
Frame	Legs	Ref	↓	↓	↓
		00			
		08			
		09	+ 306,60	+ 450,80	+ 151,20

OPTIONAL WIRING ACCESS				
MFC	PC	+ 30,80	+ 61,60	+ 30,80
	QC	+ 72,80	+ 145,60	+ 72,80
	RC	+ 95,20	+ 190,40	+ 95,20
MFC BLACK ANTI-FINGERPRINT	PC	+ 30,80	+ 61,60	+ 30,80
	QC	+ 72,80	+ 145,60	+ 72,80





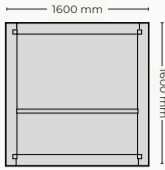
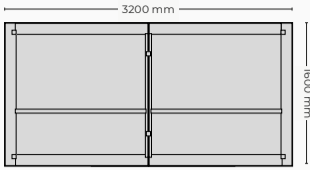
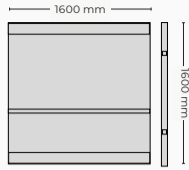





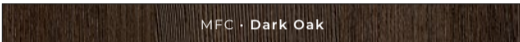

IMPORTANT NOTE:
When ordering the table with the optional **PC wiring access**, please refer to the accessories section to order the power and data connection integrated in the table top. The optional **PC wiring access** only includes the cut-out in the table top.

Meeting desks Width 1600 mm				
	MEASURES	1600 x 1600 mm	3200 x 1600 mm	1600 x 1600 mm · Extension desk
	HEIGHT	Height 740 mm	Height 740 mm	Height 740 mm
	REFERENCE	LM1G011616C	LM1G013216C	LM1G021616C

STRUCTURE				
Straight legs	B	1.041,60	1.755,60	894,60

SUPPORT				
Levelers	F			
Height adjustment system	C	+ 214,20	+ 320,60	+ 107,80

FINISHES SURFACE				
	M00			
	M11			
	M10			
	M07			
	M14			
	M03	+ 637,00	+ 1.274,00	+ 637,00

FINISHES STRUCTURE					
Frame	Legs	Ref	↓	↓	↓
		00			
		08			
		09	+ 306,60	+ 450,80	+ 151,20

OPTIONAL WIRING ACCESS				
MFC	PC	+ 30,80	+ 61,60	+ 30,80
	QC	+ 72,80	+ 145,60	+ 72,80
	RC	+ 95,20	+ 190,40	+ 95,20
MFC BLACK ANTI-FINGERPRINT	PC	+ 30,80	+ 61,60	+ 30,80
	QC	+ 72,80	+ 145,60	+ 72,80



IMPORTANT NOTE:
When ordering the table with the optional **PC wiring access**, please refer to the accessories section to order the power and data connection integrated in the table top. The optional **PC wiring access** only includes the cut-out in the table top.

Available complements



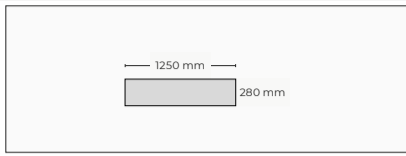
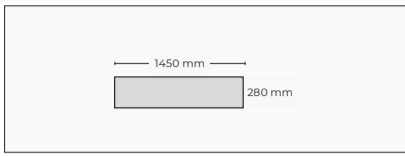
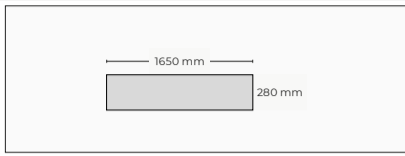



Skirts
Only for individual tables

			
MEASURES	1250 x 280 mm	1450 x 280 mm	1650 x 280 mm
COMPATIBILITY	1600 mm tables	1800 mm tables	2000 and 2200 mm tables
REFERENCE	XLMFA11228	XLMFA11428	XLMFA11628

WIDTHRING FINISH

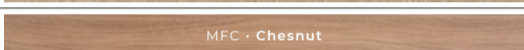
	00	92,40	95,20	96,60
	08			

SURFACE FINISH

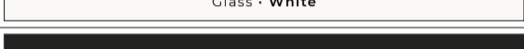
	M00			
	M11			
	M10			
	M07			
	M14			
	M08			
	V52	+ 190,40	+ 196,00	+ 214,20
	V59			

Pad manager
Desk Protector

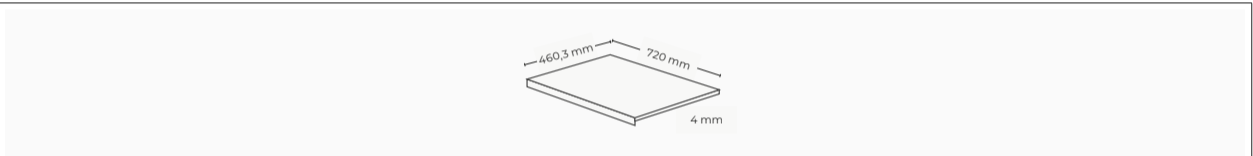
	
MEASURES	720 x 463 x 4 mm
REFERENCE	PAD5

INTEGRAL POLYURETHANE

	9	72,80
	7	

CPU support
Suspended and adjustable

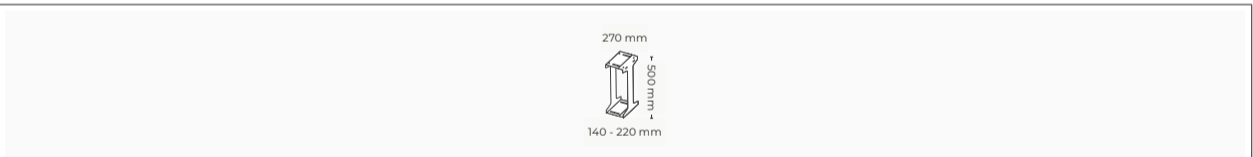
	
MEASURES	500 x 270 x 140/220 mm
COMPATIBILITY	ATX CPUs from 140 to 220 mm wide
REFERENCE	50506



SHEET METAL FINISH

	0	127,40
	8	

Longo · Operative tables

Cable risers Flexible polystyrene		
MEASURES	800 x 40,5 mm / Ø 40,5 mm	800 x 40,5 mm / Ø 70 mm
COMPATIBILITY	For use with P, Q and R access containers.	
MINIMUM UNITS ORDER	3 units · Price for 1 unit	
REFERENCE	39425	39525

FLEXIBLE POLYSTYRENE FINISH			
White	0	22,40	26,60
Black	8		

Cable risers Sheet metal		
MEASURES	520 x 80 x 50 mm	625 x 150 x 100 mm
COMPATIBILITY	For use on single, quadruple and double progression tables.	
REFERENCE	5070	5071

FINISHING SHEET METAL			
White	0	112,00	134,40
Black	8		

Cable risers Braided textile wrap		
PACKS	Pack 1 unit	Pack 4 units
MEASURES	750 mm / Ø 30 mm	
CHARACTERISTICS	Zippered for quick and easy installation. Offers additional protection against flame and abrasion.	
REFERENCE	39431	39434

FINISHING FABRIC			
Black	8	36,40	131,60

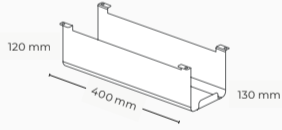
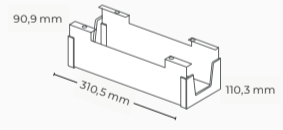
Cable container Individual tables		
MEASURES	400 x 120 x 130 mm	310,5 x 90,9 x 110,3 mm
COMPATIBILITY	Container for electrification accessories with P, Q and R wiring access.	
PACKS	Pack 1 unit	Pack 2 units
REFERENCE	CQR11	CQR12

FINISHES			
White	0	68,60	133,00
Black	8	53,20	102,20

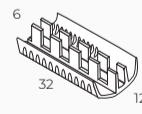
Cable management Individual tables		
MEASURES	320 x 60 x 130 mm	
COMPATIBILITY	Polystyrene cable tray, modular and articulable, with easy connection system to make a cable tray in progression. Pack of 10 modules (3 metres)	
PACKS	Pack 10 Units	
REFERENCE	XTCP0301100	

FINISHES			
White	0	68,20	
Black	8		

Power and data connection compatibility for meeting tables

Locate the requested table model to order the necessary power connection units for all meeting tables.



Example of power connection

Please refer to the following examples to order all the components required for the desired configuration. The **GX21** mains power cable must always be ordered. The power distributor **GX22** is included in the power connection with USB charging. In case of ordering a table with progressive desk and **power connection with HDMI**, the **GX22 connection spread kit** must be ordered for the progressive desk.

EXAMPLE 01

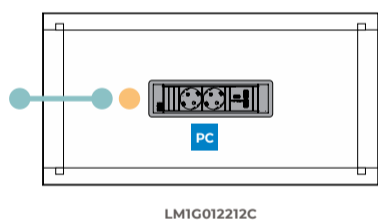

COMPONENTS	DESCRIPTION	UNITS
LM1G012212CBFM0000PC	Meeting table 220 x 120 cm with PC cable access	x1
XELBCP122081EU99	Power connection with 2 sockets + 2 USB charging sockets and without cover	x1
· GX21	2 metres extension cable, end power entry, EU · 220v	x1
· GX22	Connection spread kit	INCLUDED

EXAMPLE 02

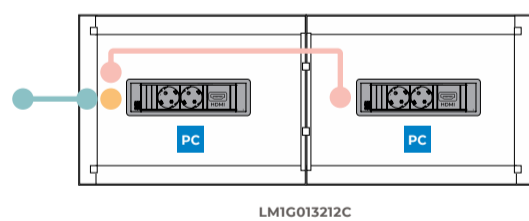

COMPONENTS	DESCRIPTION	UNITS
LM1G013212CBFM0000PC	Meeting table 320 x 160 cm with PC cable access	x1
XELBCP222081EU99	Power connection with 2 sockets + 1 HDMI and without cover	x2
· GX21	2 metres extension cable, end power entry, EU · 220v	x1
· GX22	Connection spread kit	x1
· GX20	Extension cable (1'5 m.)	x1

EXAMPLE 03

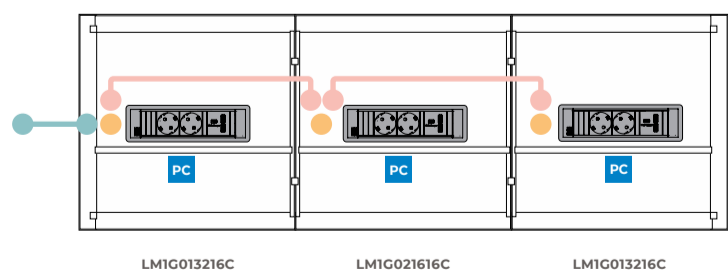

COMPONENTS	DESCRIPTION	UNITS
LM1G013216CBFM0000PC	Meeting table 320 x 160 cm with PC cable access	x1
LM1G021616CBFM0000PC	Extension table 160 x 160 cm with PC cable access	x1
XELBCP122081EU99	Power connection with 2 sockets + 2 USB charging sockets and without cover	x3
· GX21	2 metres extension cable, end power entry, EU · 220v	x1
· GX22	Connection spread kit	INCLUDED
· GX20	Extension cable (1'5 m.)	x2

Prices shown are not the final selling price.
To obtain the list price, multiply the price by 2.65.
Prices effective as February 2024.



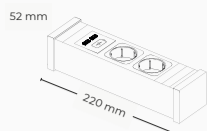
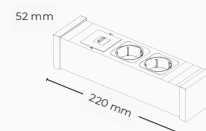
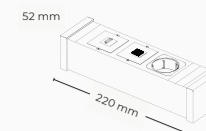

Longo · Operative tables

Power and data connection Meeting desks			
			
COMPONENTS	2 plugs + 2 USB charging sockets GX22 INCLUDED (Connection spread kit)	2 plugs + 1 HDMI	1 plug + 1 HDMI + 2 USB charging sockets GX22 INCLUDED (Connection spread kit)
COMPATIBILITY	Integrated power and data connection for meeting desks with PC wiring access		
PACKS	Pack 1 unit	Pack 1 unit	Pack 1 unit
REFERENCE	XELBCP122	XELBCP222	XELBCP322

FRAME FINISH / INITIAL PRICE			
Black	08	315,00	240,80
			380,80

CONNECTIVITY			
US · 120V	1US		
EU · 220V	1EU		
UK · 220V	1UK		

OPTIONAL TOP COVER			
Without cover	99		
White	00	+ 242,20	+ 242,20
Black	08	+ 242,20	+ 242,20

Electrical accessories Meeting tables					
					
COMPONENTS	Extension cable (1'5 m.)	End power entry 2 mts. EU · 220V	End power entry 2 mts. UK · 220V	End power entry 2 mts. US · 120V	Connection spread kit.
DESCRIPTION	Ø 10 mm. (3 x 2'5). Rubber hose Male and female connector to connect additional power module.	Ø 8 mm. (3 x 2). Rubber hose Plug and ground Ø 4'8 / 16A Female terminal plugged (with protection).			1 input / 3 outputs
MINIMUM UNITS ORDER	4 units · Price for 1 unit	4 units · Price for 1 unit	4 units · Price for 1 unit	4 units · Price for 1 unit	5 units · Price for 1 unit
REFERENCE	GX20	GX21	GX21L	GX21D	GX22
PRICE	37,80	40,60	40,60	40,60	26,60

Explanation of use of the cable tray - desks de reunión

Use of cable tray on Meeting desks of 120 cm:

To use electrification cable tray on desks of 120 cm width, request the desired/corresponding model, which is listed on the pricelist:

- 42cm width Cable tray: Usage on all Meeting desks - Length 50 cm.
- 29cm width Recessed Cable tray: Use on LMIG011612C meeting desk - Length 84 cm.
- 29cm width Recessed Cable tray: Use on LMIG012212C and LMIG013212C meeting desk - Length 104 cm.
- 29cm width Recessed Cable tray: Use on LMIG021612C meeting desk - Length 144 cm.

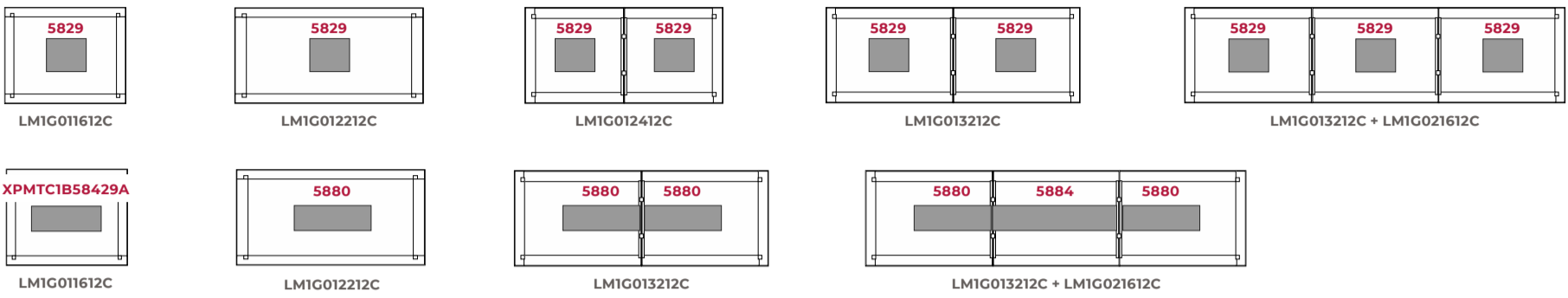

Use of cable tray on Meeting desks of 132 cm:

To use electrification cable tray on desks of 132 cm width, request the desired/corresponding model, which is listed on the pricelist:

- 42cm width Cable tray: Usage on all Meeting desks - Length 50 cm.
- 42cm width Recessed Cable tray: Use on LMIG012613C meeting desk - Length 104 cm.
- 42cm width Recessed Cable tray: Use on LMIG021313C meeting desk - Length 124 cm.

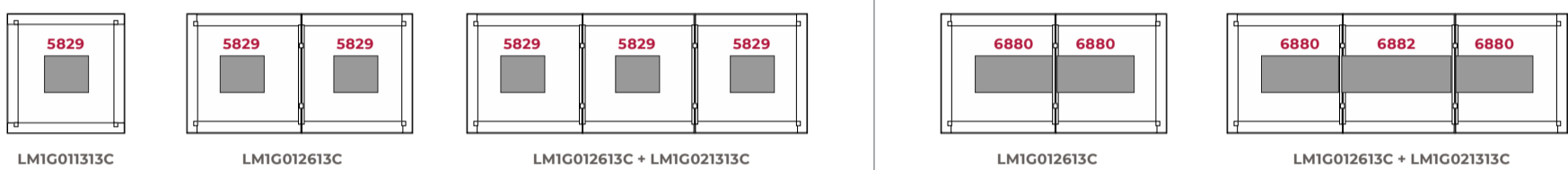

Use of cable tray on Meeting desks of 160 cm:

To use electrification cable tray on desks of 160 cm width, request the desired/corresponding model, which is listed on the pricelist:

- 42cm width Cable tray: Usage on all Meeting desks - Length 50 cm.
- 42cm width Recessed Cable tray: Use on LMIG013216C meeting desk - Length 104 cm.
- 42cm width Recessed Cable tray: Use on LMIG021616C meeting desk - Length 144 cm.

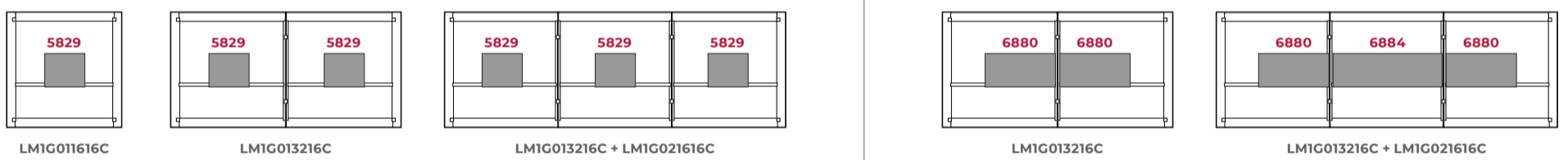

Cable tray fixed Width Meeting tables

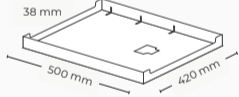
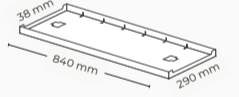
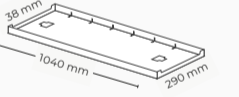
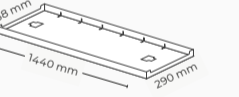
				
MEASURES	500 x 420 x 38 mm	840 x 290 x 38 mm	1000,4 x 290 x 38 mm	1440 x 290 x 38 mm
COMPATIBILITY	With meeting desk	With tables LMIG011612C	With tables LMIG013212C and LMIG012212C	With tables LMIG021612C
REFERENCE	5829	XPMTTC1B58429A	5880	5884

STRUCTURE					
White	0	70,00	91,00	99,40	119,00
Black	8				

Fixed height cable tray Meeting tables

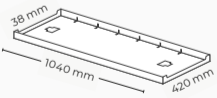
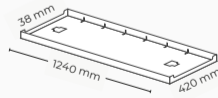
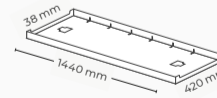
			
MEASURES	1040 x 420 x 38 mm	1240 x 420 x 38 mm	1440 x 420 x 38 mm
COMPATIBILITY	Central tables of the 1200mm progressions. - Tables for individual use of 1320 and 1600 mm. - 1320 and 1600 mm. quadruple tables or progression end tables.	Central tables of the 1320mm progressions.	Central tables of the 1600mm progressions.
REFERENCE	6880	6882	6884

STRUCTURE				
White	0	105,00	112,00	120,40
Black	8			

EXPLANATION OF USE OF THE CABLE TRAY - DOUBLE OPERATIVE DESKS AND EXTENDABLE DOUBLE DESKS

Use of cable tray on double operative desks and extendable double desks:

To use electrification cable tray on double and middle extension desks, ask for the corresponding/desired model, which is listed on the pricelist.

- 42cm width Cable tray - Length 50 cm: Usage on all Operative double desks - Length 50 cm.
- 42cm width Recessed Cable tray: Usage on all Operative double desks - Length 84 / 104 / 124 / 144 cm.

Fixed-height Cable tray compatibility for doubles, quads and progression tables

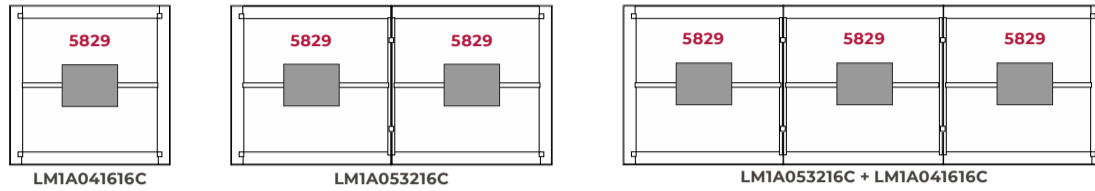

Fixed-height recessed Cable tray compatibility for doubles, quads and progression tables

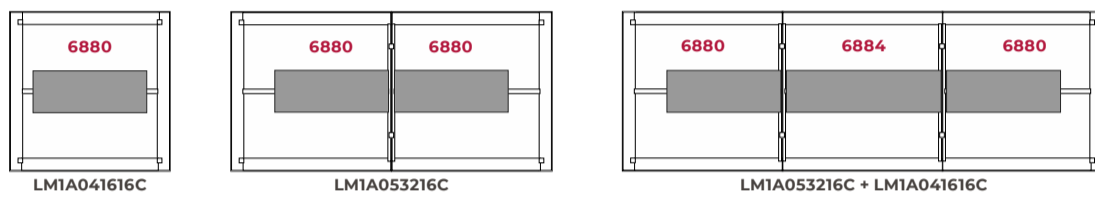

Height-adjustable recessed Cable tray compatibility for doubles, quads and progression tables

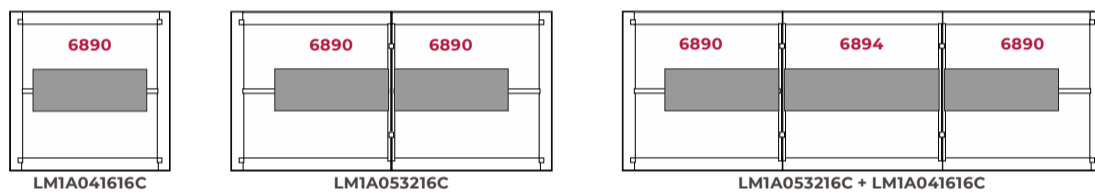

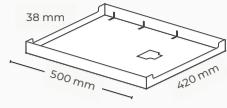
Fixed Widthr Cable tray Double, quadruple and progression tables		
	MEASURES	500 x 420 x 38 mm
	COMPATIBILITY	For use on all models of double, quadruple and progression tables .
	REFERENCE	5829

STRUCTURE		
White	0	70,00
Black	8	

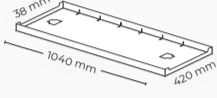
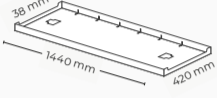
Fixed height Cable tray Double, quadruple and progression tables					
	MEASURES	1040 x 420 x 38 mm	1440 x 420 x 38 mm		
	COMPATIBILITY	Tables for individual use of 1600 mm. - 1600 mm. quadruple tables or progression end tables.	Central tables of the 1600mm progressions.		
	REFERENCE	6880	6884		

STRUCTURE				
White	0	105,00	120,40	
Black	8			

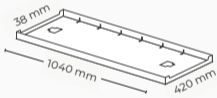
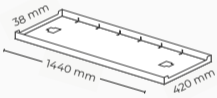
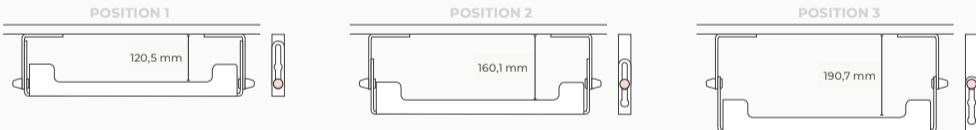
Height-adjustable Cable tray Double, quadruple and progression tables					
	MEASURES	1040 x 420 x 38 mm	1440 x 420 x 38 mm		
	POSITIONS				
	COMPATIBILITY	Tables for individual use of 1600 mm. - 1600 mm. quadruple tables or progression end tables.	Central tables of the 1600mm progressions.		
REFERENCE	6890	6894			

STRUCTURE				
White	0	145,60	162,40	
Black	8			

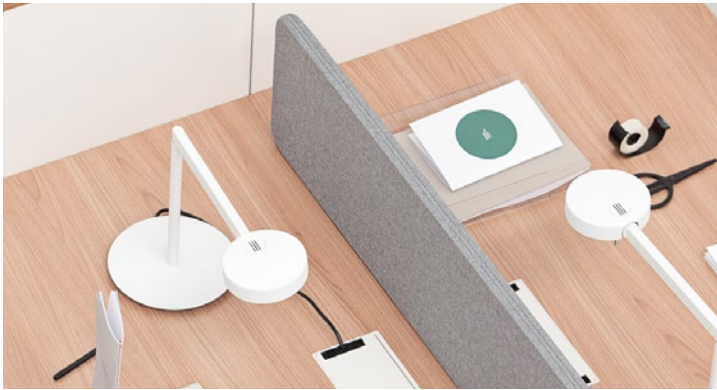

■ **Desks mounted screens**

Desk-Mounted screens, different sizes available, fixing kits and finishes. Easy to be adapted to any surface. They provide visual contact but at the same time privacy. Twin desks with electrification system have their own desk-mounted screens (**ID50 Serie for Vital or Arkitek**)

■ **DESK MOUNTED SCREENS OFFER**

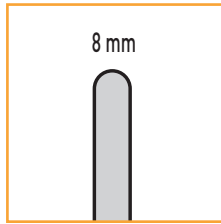

GLASS SCREEN - e=8mm

Laminatd Security Glass (4+4 mm) / Tempered glass (8 mm)

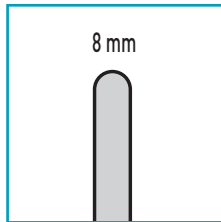

METHACRYLATE SCREEN - e=8mm

8 mm thick White Methacrylathe

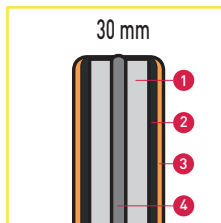

UPHOLSTERED SCREEN WITH FLEXIBLE PROFILE - e=30mm

- ① 19 mm thick Chipboard
- ② Foam thickness e= 5 mm and 60 Kg/m³ density (etotal= 30 mm)
- ③ Different fabrics available glued using water glue.
- Optional accoustic or fire resistant fabrics for projects.
- ④ 8mm thick flexible Profile

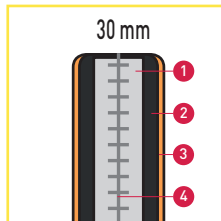

UPHOLSTERED SCREEN. SEWAN AND SEATHED - e=30mm



- ① 19 mm thick Chipboard
- ② Foam thickness e= 5 mm and 60 Kg/m³ density (etotal= 30 mm)
- ③ Different fabrics available glued using water glue.
- Optional accoustic or fire resistant fabrics for projects.
- ④ Sewn and sheathed.



Prices shown are not the final selling price.
To obtain the list price, multiply the price by 2.65.
Prices effective as February 2024.

EXAMPLE OF AN ORDER

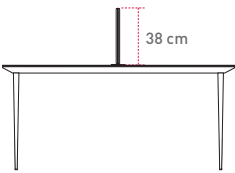
Model	Bracket finish	Divider Finish	Final Reference
DLN432 Screen mobile Pack 2 units	N Black bracket	T82 Sewn and Sheathed upholstered - e=30mm Group T Upholstered	DLN432NT82

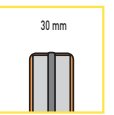

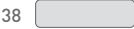

TABLE TOP DIVIDERS FOR: USE ON DOUBLE DESKS ET INDIVIDUAL DESKS AND CROSS USE ON DOUBLE PROGRESSIVE DESKS



			
	Support on discs with anti slip pad.	Upholstered divider e=30 mm	Upholstered divider e=30 mm

Model Dimensions (A x B)	ZW43 110 38 	ZW44 130 38 	ZW45 150 38 
	TABLE TOP DIVIDER FOR 120, 140 and 160 cm DESK	TABLE TOP DIVIDER FOR 140 and 160 cm DESK	TABLE TOP DIVIDER FOR 160 cm DESK

Units / Pack		Pack 1 Unit	Pack 2 Units	Pack 1 Unit	Pack 2 Units	Pack 1 Unit	Pack 2 Units
Base Reference		ZW431	ZW432	ZW441	ZW442	ZW451	ZW452
Bracket finish	WHITE	0					
	BLACK	8					







FLEXIBLE PROFILE UPHOLSTERED DIVIDER e= 30 mm - h= 38 cm

Upholstered e=30 Flexible profile	GROUP 0		Group T	3T--	180,60	344,40	186,20	358,40	198,80	386,40
		GROUP 1		Group AE	3AE--	207,20	397,60	218,40	422,80	259,00
			Group AO	3AO--						
	GROUP 2		Group D	3D--	217,00	425,60	232,40	450,80	287,00	558,60
			Group M	3M--						

Model Dimensions (A x B)	DLN43 110 38 	DLN44 130 38 	DLN45 150 38 
	TABLE TOP DIVIDER FOR 140 and 160 cm DESK	TABLE TOP DIVIDER FOR 140 and 160 cm DESK	TABLE TOP DIVIDER FOR 160 cm DESK

Units / Pack		Pack 1 Unit	Pack 2 Units	Pack 1 Unit	Pack 2 Units	Pack 1 Unit	Pack 2 Units
Base Reference		DLN431	DLN432	DLN441	DLN442	DLN451	DLN452
Bracket finish	WHITE	B					
	BLACK	N					

SEWN AND SHEATHED UPHOLSTERED DIVIDER e= 30 mm - h= 38 cm

Upholstered e=30 Sewn and sheathed	GROUP 0		Group T	T--	212,80	414,40	218,40	428,40	235,20	456,40
		GROUP 1		Group AE	AE--	239,40	467,60	253,40	498,40	294,00
			Group AO	AO--						
	GROUP 2		Group D	D--	252,00	494,20	267,40	522,20	320,60	628,60
			Group M	M--						
	GROUP 3		Group A	A--	298,20	585,20	319,20	625,80	380,80	749,00

Prices shown are not the final selling price.
 To obtain the list price, multiply the price by 2.65.
 Prices effective as February 2024.

EXAMPLE OF AN ORDER

Model	Bracket finish	Divider Finish	Final Reference
DPM432 Screen for frontal use Pack 2 units	N Black bracket	T82 Group T Upholstered	DPM432NT82

TABLE TOP DIVIDERS FOR FRONTAL USE ON DOUBLE DESKS

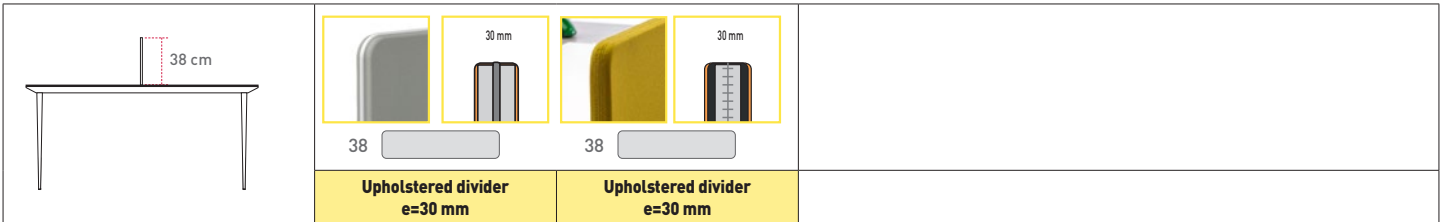

Model Dimensions (A x B)	ZL43 110 38	ZL44 130 38	ZL45 150 38
	TABLE TOP DIVIDER FOR 120 and 160 cm DESK	TABLE TOP DIVIDER FOR 140 and 160 cm DESK	TABLE TOP DIVIDER FOR 160 cm DESK

Coding required to configure reference.
 They do not mean an increase in cost

Units / Pack		Pack 1 Unit	Pack 2 Units	Pack 1 Unit	Pack 2 Units	Pack 1 Unit	Pack 2 Units
Base Reference		ZL431	ZL432	ZL441	ZL442	ZL451	ZL452
Bracket finish	WHITE	0					

FLEXIBLE PROFILE UPHOLSTERED DIVIDER e= 30 mm - h= 38 cm

Upholstered 1 1/2" Flexible profile	GROUP 0	Group T	3T--	154,00	294,00	159,60	306,60	172,20	333,20
	GROUP 1	Group AE	3AE--	180,60	347,20	191,80	371,00	232,40	453,60
		Group AO	3AO--						
	GROUP 2	Group D	3D--	193,20	373,80	205,80	400,40	261,80	508,20
		Group M	3M--						

Model Dimensions (A x B)	DPM43 110 38	DPM44 130 38	DPM45 150 38
	TABLE TOP DIVIDER FOR 120 and 160 cm DESK	TABLE TOP DIVIDER FOR 140 and 160 cm DESK	TABLE TOP DIVIDER FOR 160 cm DESK

Units / Pack		Pack 1 Unit	Pack 2 Units	Pack 1 Unit	Pack 2 Units	Pack 1 Unit	Pack 2 Units
Base Reference		DPM431	DPM432	DPM441	DPM442	DPM451	DPM452
Bracket finish	WHITE	B					

SEWN AND SHEATHED UPHOLSTERED DIVIDER e= 30 mm - h= 38 cm

Upholstered 1 1/2" Sewn and sheathed	GROUP 0	Group T	T--	187,60	362,60	194,60	378,00	208,60	403,20
	GROUP 1	Group AE	AE--	214,20	415,80	229,60	448,00	267,40	520,80
		Group AO	AO--						
	GROUP 2	Group D	D--	225,40	441,00	242,20	470,40	295,40	575,40
		Group M	M--						
	GROUP 3	Group A	A--	273,00	533,40	294,00	572,60	354,20	694,40

Prices shown are not the final selling price.
 To obtain the list price, multiply the price by 2.65.
 Prices effective as February 2024.

EXAMPLE OF AN ORDER

Model	Divider Finish	Bracket finish	Final Reference
DPM432 Screen for frontal use Pack 2 units	90 White Methacrylate	B White bracket	DPM43290B

TABLE TOP DIVIDERS FOR FRONTAL USE ON DOUBLE DESKS

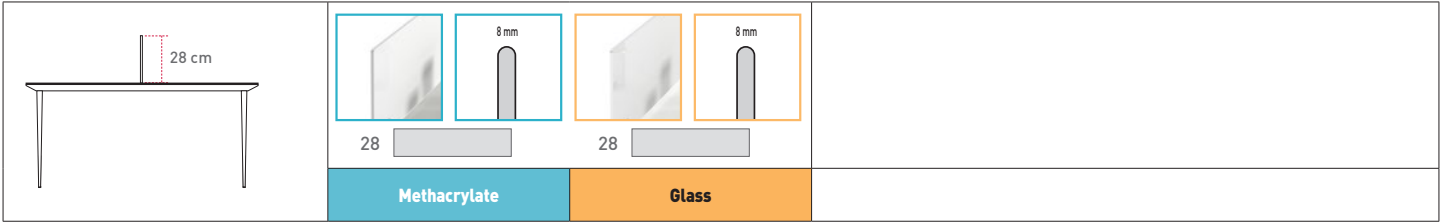

Model Dimensions (A x B)	DPM43		DPM44		DPM45	
	110	130	150			
	28	28	28			
	TABLE TOP DIVIDER FOR 140, 160 and 180 cm DESK		TABLE TOP DIVIDER FOR 140, 160 and 180 cm DESK		TABLE TOP DIVIDER FOR 160 and 180 cm DESK	
Units / Pack	Pack 1 Unit	Pack 2 Units	Pack 1 Unit	Pack 2 Units	Pack 1 Unit	Pack 2 Units
Base Reference	DPM431	DPM432	DPM441	DPM442	DPM451	DPM452

METHACRYLATE DIVIDER e = 8 mm - h = 28 cm

Methacrylate	White	90	110		130		150	
			Pack 1 Unit	Pack 2 Units	Pack 1 Unit	Pack 2 Units	Pack 1 Unit	Pack 2 Units
			141,40	271,60	155,40	295,40	165,20	319,20

GLASS DIVIDER e = 8 mm - h = 28 cm

Glass	White	52	110		130		150	
			Pack 1 Unit	Pack 2 Units	Pack 1 Unit	Pack 2 Units	Pack 1 Unit	Pack 2 Units
			246,40	481,60	274,40	533,40	301,00	588,00

Bracket finish	WHITE		110		130		150	
	B	N	Pack 1 Unit	Pack 2 Units	Pack 1 Unit	Pack 2 Units	Pack 1 Unit	Pack 2 Units

 Coding required to configure reference.
 They do not mean an increase in cost