

Prices shown are not the final selling price.
To obtain the list price, multiply the price by 2.65.
Prices effective as February 2024.

PRISMA

By Sylvain Carlet &
Isern Serra



Program of tables

Individual operating tables · Width 800 mm

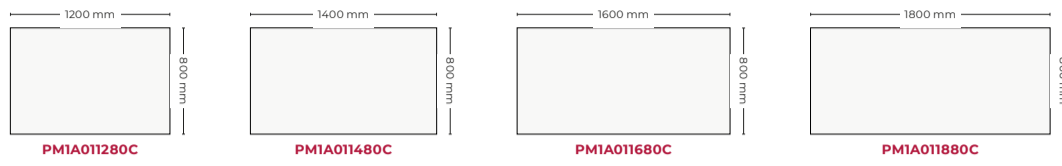

Auxiliary tables & Returns · Wide 600 mm

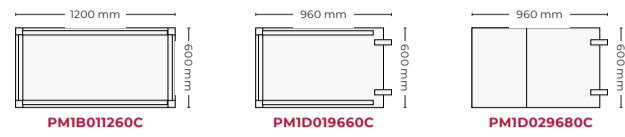

Double & Progression tables · Wide 1600 mm

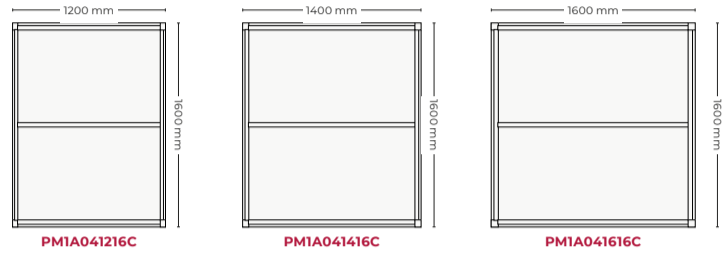

Quadruple & Progression tables · Wide 1600 mm

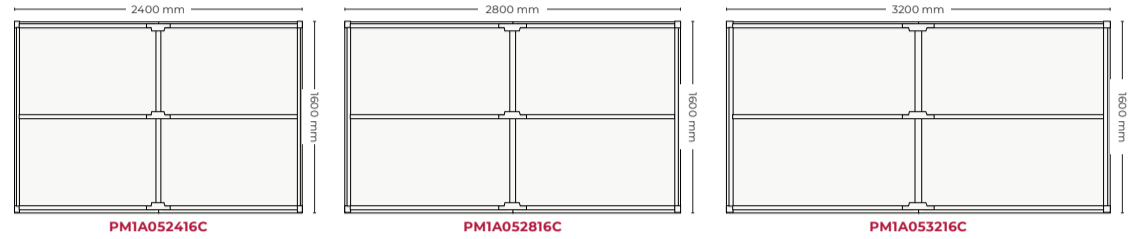

Progression tables · Width 1600 mm

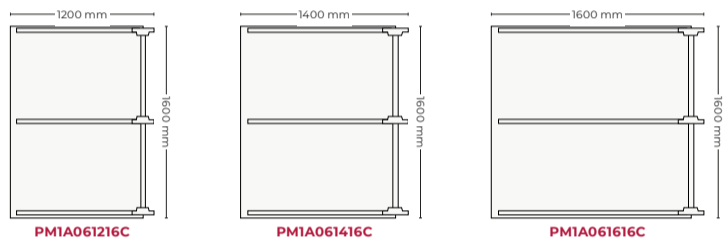

Meeting tables · Width 1000 mm

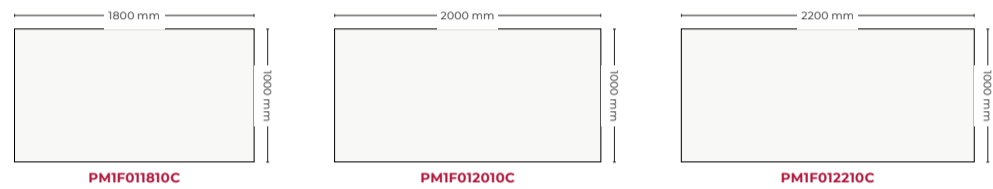

Tables with file support · Width 800 mm

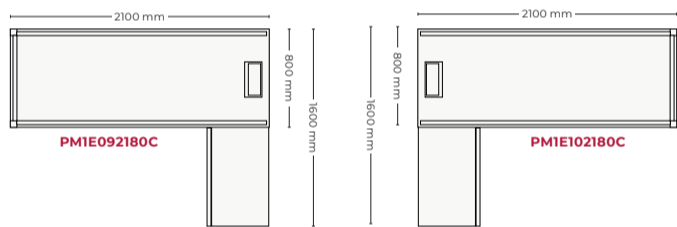

Double tables with file support · Width 1600 mm

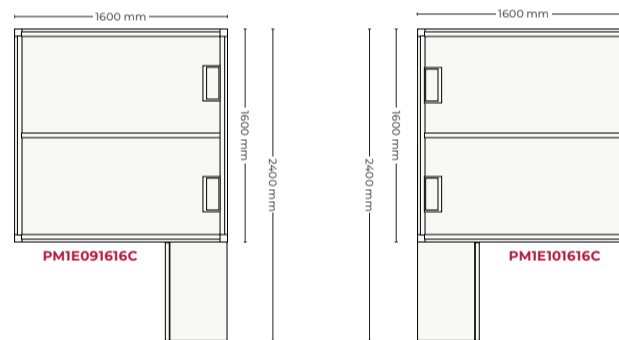

Meeting tables · Width 1200 mm

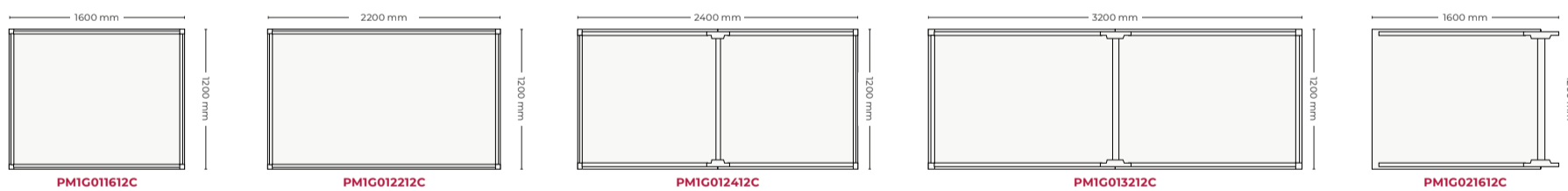

Meeting tables · Width 1400 mm

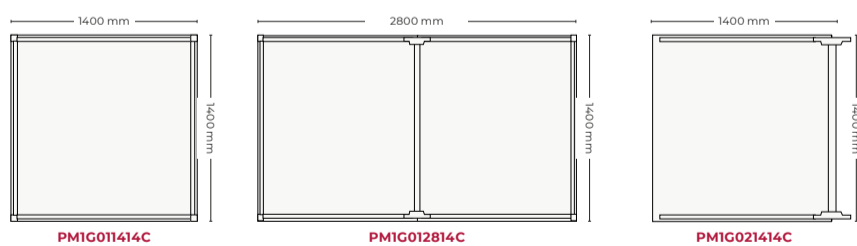

Meeting tables · Width 1600 mm

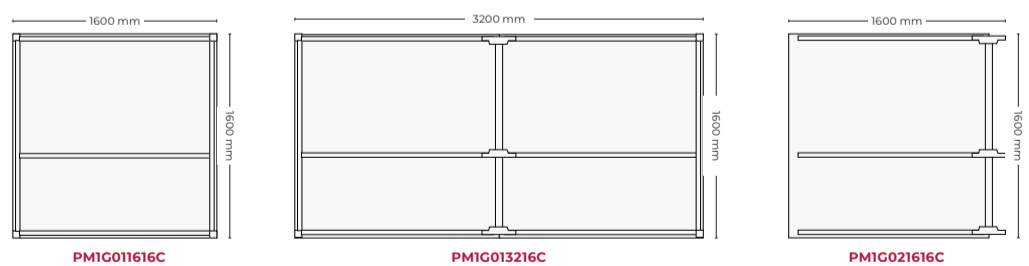

Meeting tables · Height 1000 mm

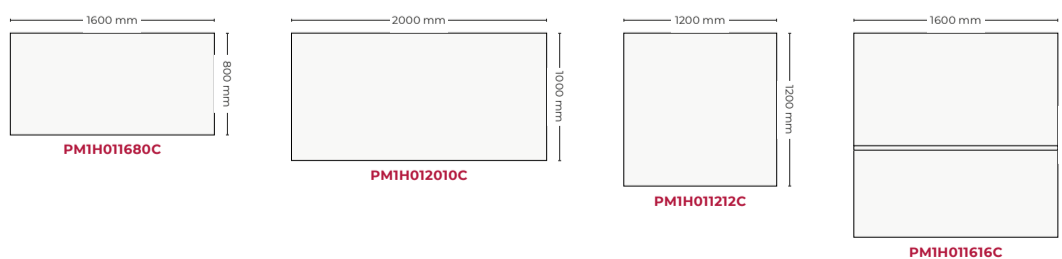

Auxiliary files · Height 690 mm

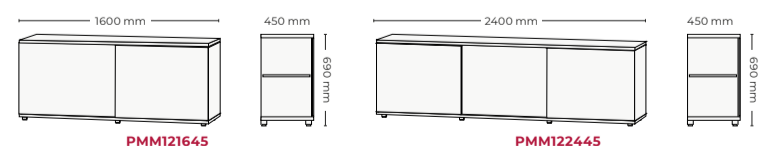

Functionalities



Description of model with steel supports

- 1** Table top made of melamine with 5 cm edge.
- 2** Metallic legs of 5x5 cm with quick joint system. Internal metallic structure in steel tube 3x3 cm.
- 3** Leveling support made of PP with anti-slip soleplate.
- 4** Suspended electrification channel for double tables with height adjustment.
- 5** Tabletop divider upholstered with sound-absorbing properties anchored to the structure.
- 6** Leg covered with metal totem for cable ducting.
- 7** Push Latch "T" electrification output.

Surfaces and structure

Table tops made of 19 mm chipboard with steel bottom structure. Tabletop thickness of 5 cm made of 1.9 cm perimeter molding with 2 mm thick rounded edge, highly durable and recyclable. 5x5 cm section leg structure made of 1.5 mm thick hot-rolled and pickled steel profile, finished with epoxy paint in white and wood-like finishes. Table top structure of section 3x3 cm made of hot-rolled steel profile and pickled 2 mm thick, in black and white finish.

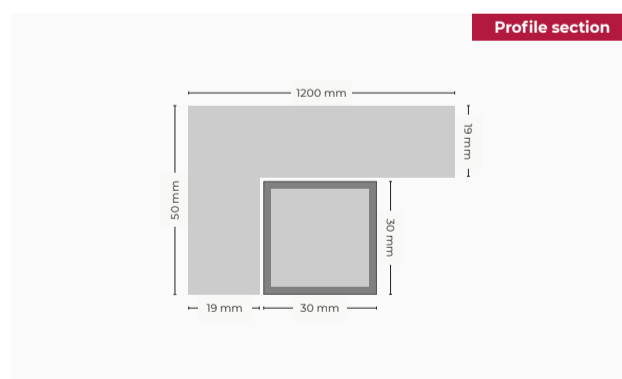

Recessed legs



Straight 1600 mm and 1200 mm wide tables with progression and central legs recessed from the table edge for operational configurations of 4 or more workstations or meeting tables, facilitating mobility. **Recessed leg 410 mm on 1600 mm tables and 310 mm on 1200 mm tables.**

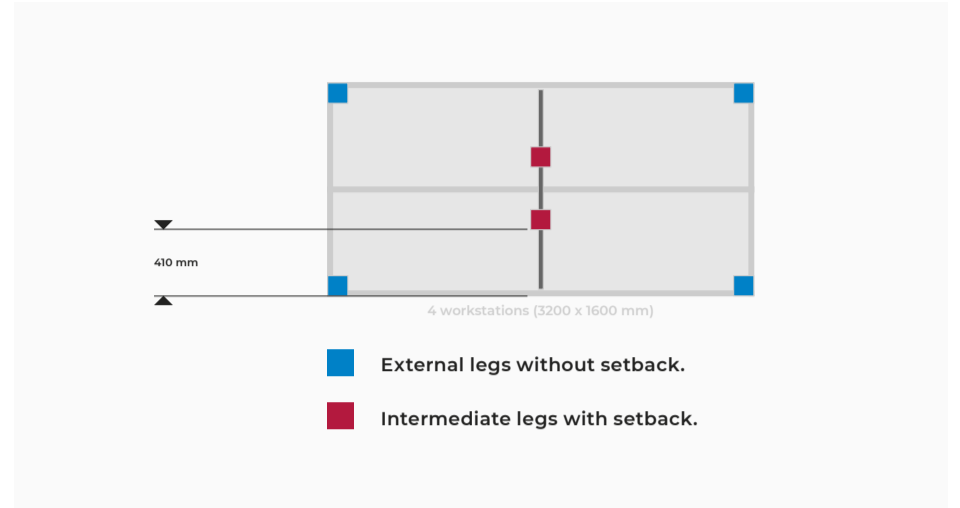

Finishes



Available finish combinations



Configurations

Table with support in credenza unit



- Filing cabinet made of melamine available in various finishes.
- Sliding doors made of melamine.
- Integrated guides made of extruded PVC profile. **Smooth glide.**
- **Two sizes available:** 1600 and 2400 mm length, 450 mm width and 690 mm height.
- Inner grille with anchoring system that allows height change.
- Interior prepared for internal cable management.
- Metal legs with injected PP leveler and anti-slip soleplate.

Structural dividers

Prisma has its own system of movable dividers or those that are anchored directly to the table surface, giving it great stability and an aesthetic appearance in harmony. Fully upholstered, with aluminum profiles or guides for fixing 3rd level elements, upholstered, sound-absorbing, glass, methacrylates, the new dividers offer a large number of possibilities.



How to code a reference



	T Wiring Access	Q Wiring Access	R Wiring Access	P Wiring Access
	Maximum opening: 90°	Maximum opening: 110°	Maximum opening: 180°	Maximum opening: 180°
	<ul style="list-style-type: none"> • ABS injected lid • Frame injected in ABS • Injection-moulded polyamide clamping clips PA • Black bristle brush with zinc-plated plate profile • Polyamide guides for adjustment according to the thickness of the surface between 13 and 30 mm • Dimensions: 25 x 11,7 cm 	<ul style="list-style-type: none"> • Black die-cast aluminium frame • Die-cast aluminium lid • Aluminium guides for adjustment according to the thickness of the surface between 13 and 30 mm • Dimensions: 30,5 x 12,1 cm 	<ul style="list-style-type: none"> • Melamine lid of the same finish as the surface • Black Bristle Brush • Black die-cast aluminium frame • Aluminium guides for adjustment according to the thickness of the surface between 13 and 30 mm • Complete opening in 180° by means of hinges. • Dimensions: 30,5 x 12,1 cm 	<ul style="list-style-type: none"> • The wiring access P only includes the cut-out in the table top. • If you order the desking with the optional PC wiring access, please refer to the accessories section to order the integrated power and data connection in the desk top. • Compact solution for integrated power and data connection with easy workstation access. • Different configuration combinations for a wide range of applications. • Perimeter frame in black aluminium. • Optional integrated aluminium cover to protect connections against dust and dirt. Available in black and white. • Total dimensions: 241 x 73 mm • Total dimensions cover: 257 x 87 mm • Junction box top surface dimensions: 225 x 60 mm

-Models with this standard cable access has the icon next to the code
 -Desk price with the cable access is as per the attached table.

-To order different desks which the electrification access is not standard, please check sales team.

-To order desks with cable access, please add the corresponding letter according to the desired placement, at the end of the reference:

WIRING ACCESS

	FRONT CENTERED ACCESS	LEFT HAND SIDE	RIGHT HAND SIDE	CENTERED ACCESS
	TF QF RF	TL QL RL	TR QR RR	PC QC RC

IMPORTANT NOTE:

The combination of wired access is carried out in the following way:
 (If in any case you want the upper access in different finishing established, the customer must indicate it on the order.)

MELAMINE SURFACE FINISHES AND STRUCTURE		COMBINATIONS OF FINISHES OFFERED			
Surface	Sides	T WIRING ACCES	Q WIRING ACCES	R WIRING ACCES	P WIRING ACCES
WHITE	WHITE	WHITE	WHITE	WHITE	WHITE
LIME OAK	LIME OAK	WHITE	WHITE	LIME OAK	WHITE
	WHITE	WHITE	WHITE	LIME OAK	BLACK
LIGHT OAK	LIGHT OAK	WHITE	WHITE	LIGHT OAK	WHITE
		WHITE	WHITE	LIGHT OAK	BLACK
CHESTNUT	CHESTNUT	WHITE	WHITE	CHESTNUT	WHITE
		WHITE	WHITE	CHESTNUT	BLACK
DARK OAK	DARK OAK	BLACK	BLACK	DARK OAK	BLACK

Superior cable access location to cabling and connections

Rectangular desks - 80 cm wide

Front access

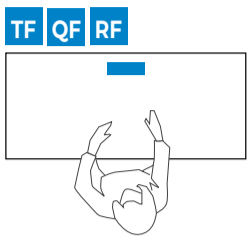

Right lateral access

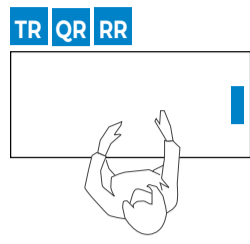

Left lateral access

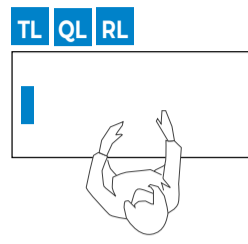

Twin and progressive desks - 160 cm wide

Front access

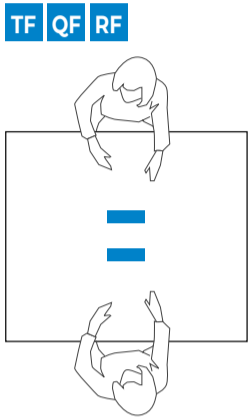

Front access

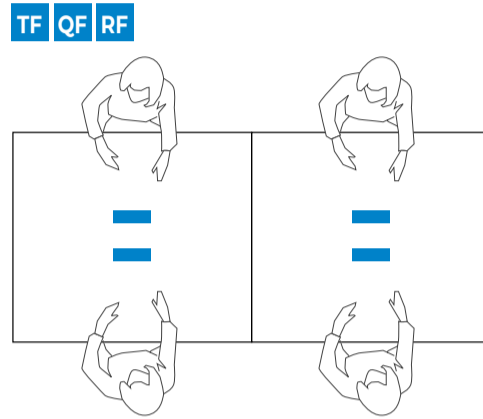

Front access

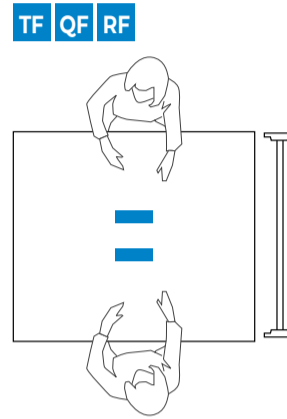

Executive and meeting desks - 100 cm wide

Front access

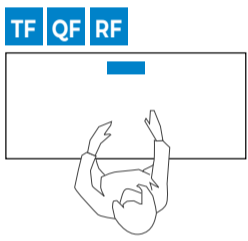

Right lateral access

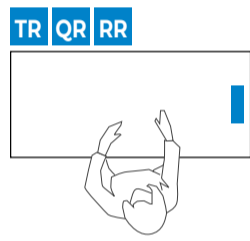

Left lateral access

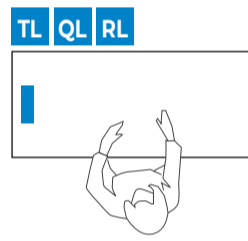

Centered access

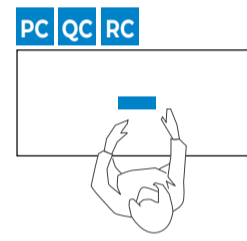

Meeting desks - 120 / 140 / 160 cm wide

Centered access

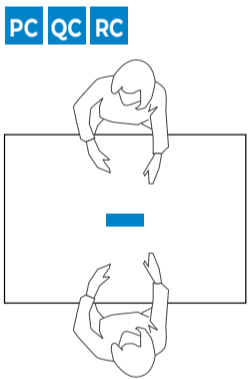

Centered access

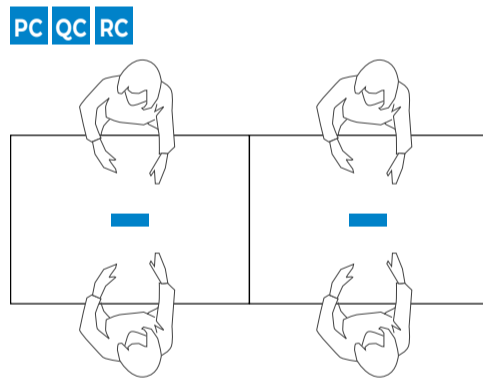

Centered access

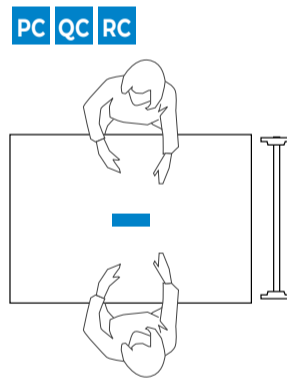

Meeting desks - 100 cm height

Centered access

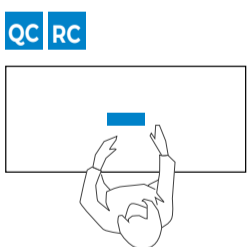

Centered access

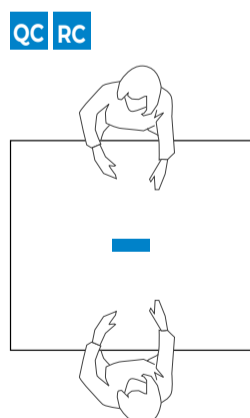

Program of tables

Individual operating tables · Width 800 mm

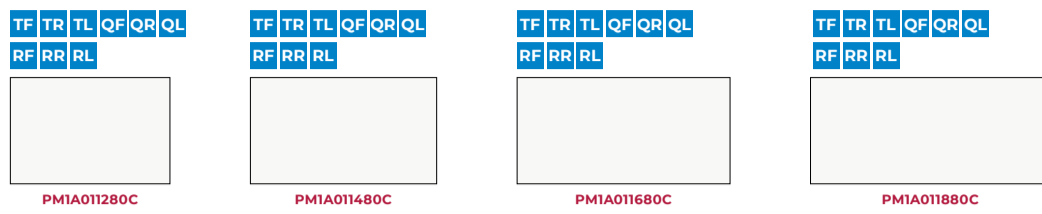

Auxiliary tables & Returns · Wide 600 mm

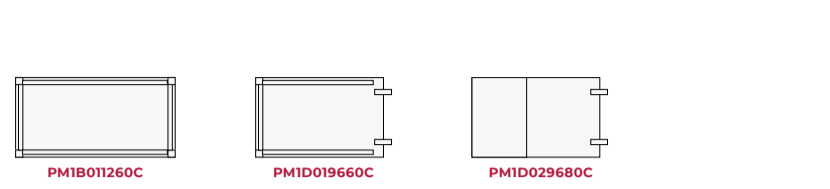

Double & Progression tables · Wide 1600 mm

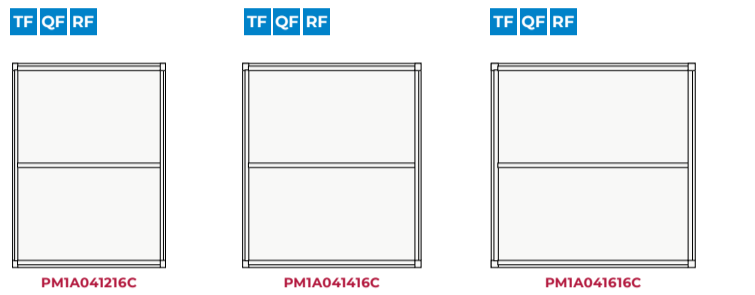

Quadruple & Progression tables · Wide 1600 mm

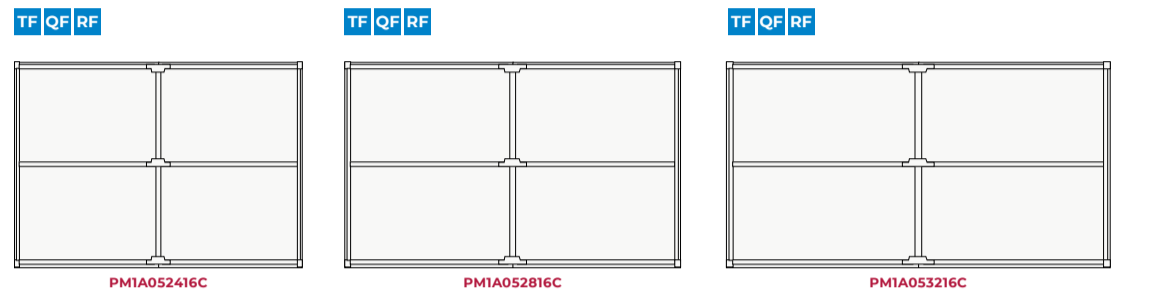

Progression tables · Width 1600 mm

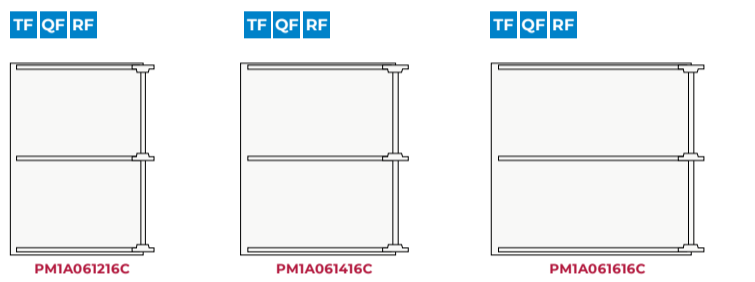

Meeting tables · Width 1000 mm

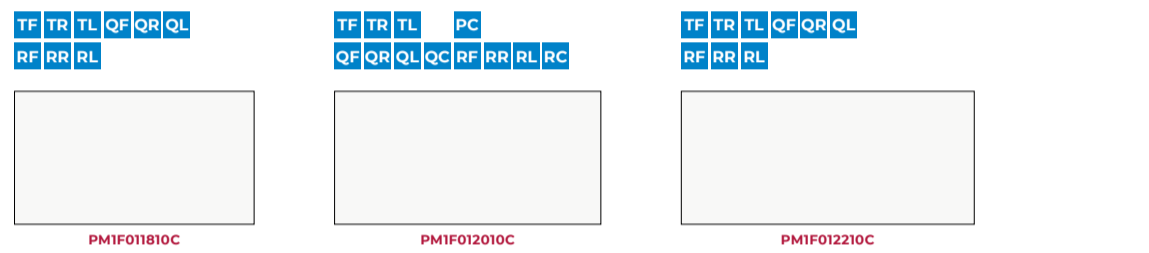

Tables with file support · Width 800 mm

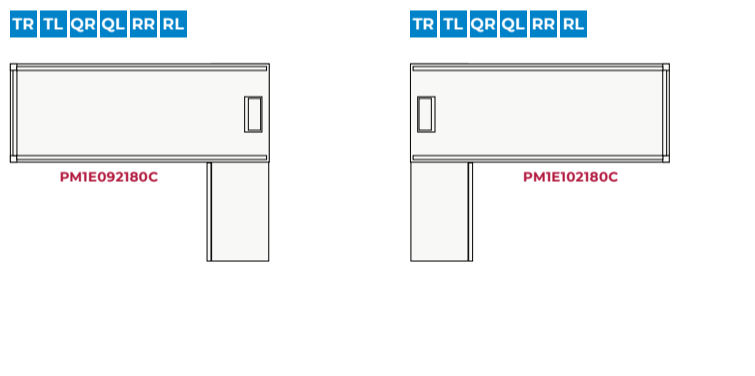

Double tables with file support · Width 1600 mm

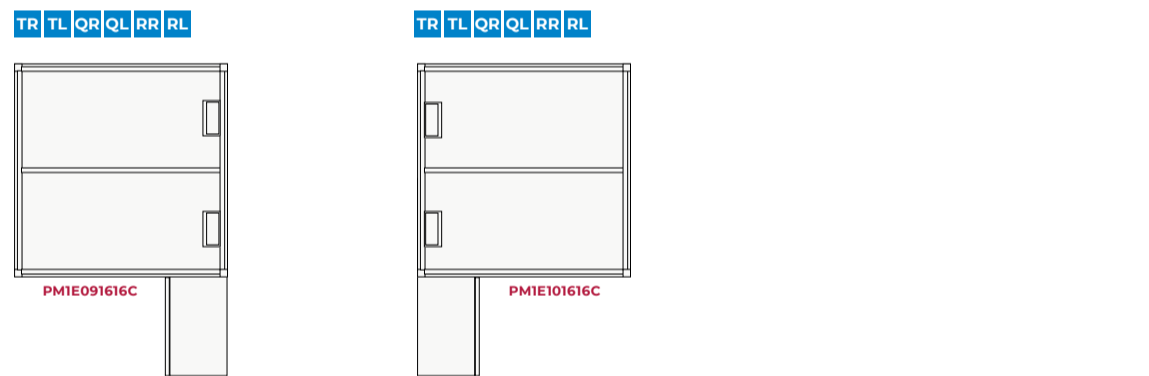

Meeting tables · Width 1200 mm

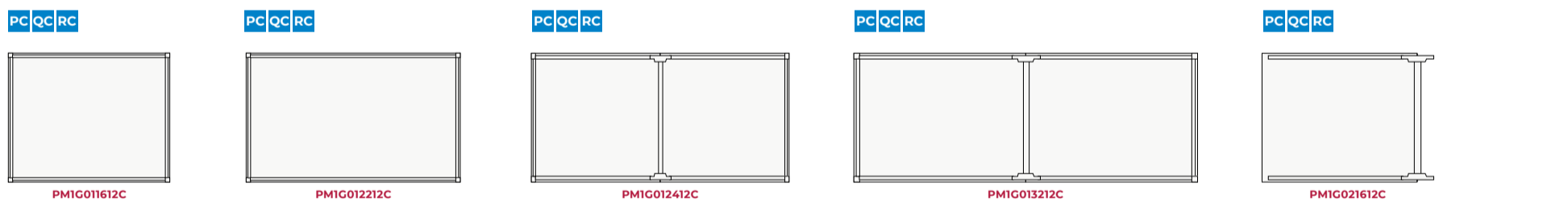

Meeting tables · Width 1400 mm

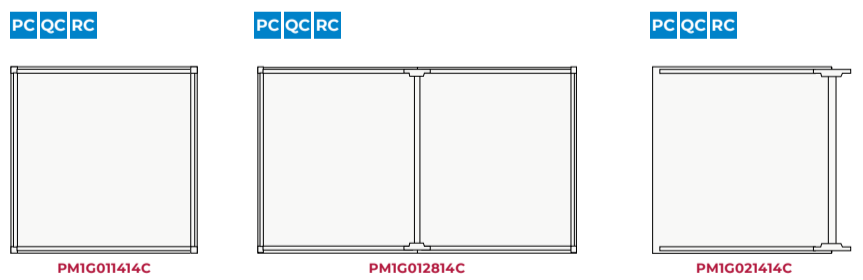

Meeting tables · Width 1600 mm

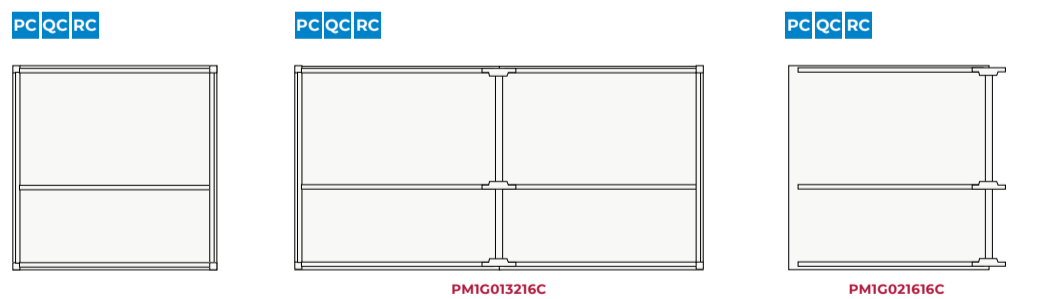

Meeting tables · Height 1000 mm

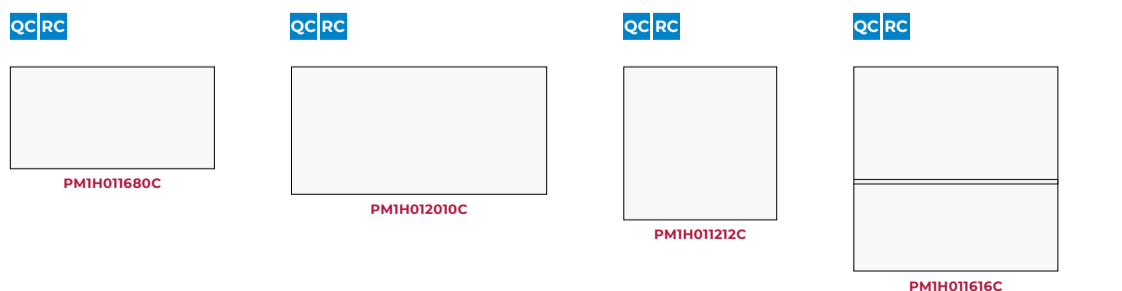



Individual operating tables Width 800 mm					
MEASURES		1200 x 800 mm	1400 x 800 mm	1600 x 800 mm	1800 x 800 mm
LEVELERS		Height 740 mm	Height 740 mm	Height 740 mm	Height 740 mm
REFERENCE		PMIA011280C	PMIA011480C	PMIA011680C	PMIA011880C

STRUCTURE					
Straight legs	B	519,40	533,40	554,40	588,00

SUPPORT					
Levelers	F				

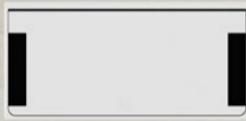
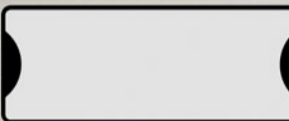
FINISHES							
Surface	Edge	Structure	Ref.	↓	↓	↓	↓
White			M0000				
White	Lime Oak		M8111	+ 67,20	+ 67,20	+ 67,20	+ 67,20
	Lime Oak		M1111				
	Light Oak		M1010				
	Chestnut		M0707				
	Dark Oak		M1414				



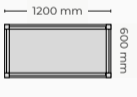
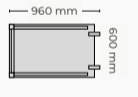
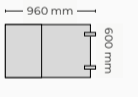

OPTIONAL WIRED ACCESS							
		TF		+ 43,40	+ 43,40	+ 43,40	+ 43,40
		TL					
		TR					
		QF		+ 75,60	+ 75,60	+ 75,60	+ 75,60
		QL					
		QR					
		RF		+ 96,60	+ 96,60	+ 96,60	+ 96,60
		RL					
		RR					

Auxiliary tables and Returns Width 600 mm				
MEASURES		1200 x 600 mm	960 x 600 mm	Auxiliary wing: 2 drawers + drawer tray.
LEVELERS		Height 740 mm	Height 740 mm	Height 740 mm
REFERENCE		PMIB011260C	PMID019660C	PMID029680C

STRUCTURE					
Straight legs	B	483,00	378,00	477,40	

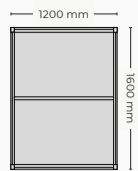
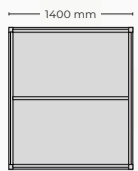
SUPPORT					
Levelers	F				

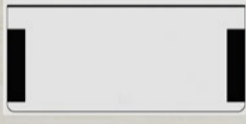
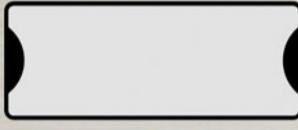
FINISHES							
Surface	Edge	Structure	Ref.	↓	↓	↓	↓
White			M0000				
White	Lime Oak		M8111	+ 67,20	+ 35,00	+ 0,00	
	Lime Oak		M1111				
	Light Oak		M1010				
	Chestnut		M0707				
	Dark Oak		M1414				

Double and progression tables Width 1600 mm						
MEASURES				1600 x 1200 mm	1400 x 1600 mm	1600 x 1600 mm
LEVELERS				Height 740 mm	Height 740 mm	Height 740 mm
REFERENCE				PM1A041216C	PM1A041416C	PM1A041616C
STRUCTURE						
Straight legs		B	845,60	883,40	897,40	
SUPPORT						
Levelers		F				
FINISHES						
Surface	Edge	Structure	Ref.	↓	↓	↓
White			M0000			
White	Lime Oak		M8111	+ 67,20	+ 67,20	+ 67,20
	Lime Oak		M1111			
	Light Oak		M1010			
	Chestnut		M0707			
	Dark Oak		M1414			
OPTIONAL WIRED ACCESS						
			TF	+ 86,80	+ 86,80	+ 86,80
			QF	+ 151,20	+ 151,20	+ 151,20
			RF	+ 193,20	+ 193,20	+ 193,20



Quadruple and progression tables Width 1600 mm			
MEASURES	2400 x 1600 mm	2800 x 1600 mm	3200 x 1600 mm
LEVELERS	Height 740 mm	Height 740 mm	Height 740 mm
REFERENCE	PMIA052416C	PMIA052816C	PMIA053216C



STRUCTURE			
Straight legs	B	1.600,20	1.663,20

SUPPORT			
Levelers	F		

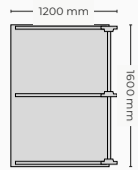
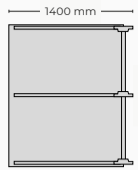
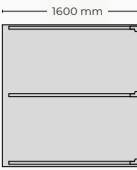
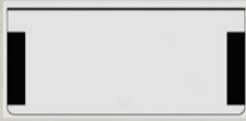
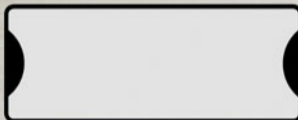
FINISHES						
Surface	Edge	Structure	Ref.			
White			M0000			
White	Lime Oak		M8111	+ 100,80	+ 100,80	+ 100,80
	Lime Oak		M1111			
	Light Oak		M1010			
	Chestnut		M0707			
	Dark Oak		M1414			

OPTIONAL WIRED ACCESS			
	TF	+ 173,60	+ 173,60
	QF	+ 302,40	+ 302,40
	RF	+ 386,40	+ 386,40

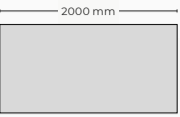

Progression tables Width 1600 mm						
MEASURES				1600 x 1200 mm	1400 x 1600 mm	1600 x 1600 mm
LEVELERS				Height 740 mm	Height 740 mm	Height 740 mm
REFERENCE				PM1A061216C	PM1A061416C	PM1A061616C
STRUCTURE						
Straight legs		B	723,80	739,20	753,20	
SUPPORT						
Levelers		F				
FINISHES						
Surface	Edge	Structure	Ref.	↓	↓	↓
White			M0000			
White	Lime Oak		M8111	+ 33,60	+ 33,60	+ 33,60
	Lime Oak		M1111			
	Light Oak		M1010			
	Chestnut		M0707			
	Dark Oak		M1414			
OPTIONAL WIRED ACCESS						
			TF	+ 86,80	+ 86,80	+ 86,80
			QF	+ 151,20	+ 151,20	+ 151,20
			RF	+ 193,20	+ 193,20	+ 193,20

Meeting tables Width 1000 mm				
	MEASURES	1800 x 1000 mm	2000 x 1000 mm	2200 x 1000 mm
	LEVELERS	Height 740 mm	Height 740 mm	Height 740 mm
	REFERENCE	PM1F011810C	PM1F012010C	PM1F012210C

STRUCTURE				
Straight legs	B	673,40	691,60	785,40

SUPPORT				
Levelers	F			

FINISHES						
Surface	Edge	Structure	Ref.	↓	↓	↓
White			M0000			
White	Lime Oak		M8111	+ 67,20	+ 67,20	+ 67,20
	Lime Oak		M1111			
	Light Oak		M1010			
	Chestnut		M0707			
	Dark Oak		M1414			

OPTIONAL WIRED ACCESS				
	PC			30,80
	TF			+ 43,40
	TL		+ 43,40	
	TR		+ 43,40	
	QF			+ 75,60
	QC		+ 75,60	
	QL		+ 75,60	
	QR		+ 75,60	
	RF			+ 96,60
	RC		+ 96,60	
	RL		+ 96,60	
	RR		+ 96,60	

	<p>IMPORTANT NOTE:</p> <p>When ordering the table with the optional PC wiring access, please refer to the accessories section to order the power and data connection integrated in the table top. The optional PC wiring access only includes the cut-out in the table top.</p>
---	--

Tables with file support Width 800 mm			
	MEASURES	2100 x 800 mm - Cabinet on the right	2100 x 800 mm - Cabinet on the left
	LEVELERS	Height 740 mm	Height 740 mm
	REFERENCE	PM1E092180C	PM1E102180C

STRUCTURE			
Straight legs	B	1.163,40	1.163,40

SUPPORT			
Levelers	F		

FINISHES						
Table		Credenza unit		Table	Ref.	↓
Surface	Edge	Body	Structure	Estructura		
White					M00M0000	
White	Lime Oak	White	Lime Oak		M81M0011	
Lime Oak					M11M1111	
Light Oak		White	Light Oak		M10M0010	
Light Oak					M10M1010	+ 33,60
Chestnut		White	Chestnut		M07M0007	
Chestnut					M07M0707	
Dark Oak					M14M1414	

WIRED ACCESS REQUIRED			
	TR	+ 43,40	
	TL		+ 43,40
	QR	+ 75,60	
	QL		+ 75,60
	RR	+ 96,60	
	RL		+ 96,60

Double tables with file support Width 1600 mm				
	MEASURES		1600 x 1600 mm - Cabinet on the right	
	LEVELERS		Height 740 mm	
	REFERENCE		PM1E091616C	

STRUCTURE			
Straight legs	B	1.744,40	1.744,40

SUPPORT			
Levelers	F		

FINISHES						
Table		Credenza unit		Table	Ref.	↓
Surface	Edge	Body	Structure	Estructura		
White					M00M0000	
White	Lime Oak	White	Lime Oak		M81M0011	
Lime Oak					M11M1111	
Light Oak	White	Light Oak	White		M10M0010	+ 33,60
Light Oak					M10M1010	+ 33,60
Chestnut	White	Chestnut	White		M07M0007	
Chestnut					M07M0707	
Dark Oak					M14M1414	

WIRED ACCESS REQUIRED			
	TR	+ 86,80	
	TL		+ 86,80
	QR	+ 151,20	
	QL		+ 151,20
	RR	+ 151,20	
	RL		+ 151,20

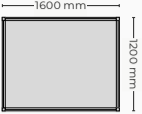
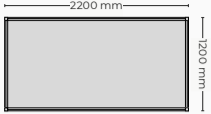
Meeting desk Width 1200 mm					
	MEASURES	1600 x 1200 mm		2200 x 1200 mm	
	LEVELERS	Height 740 mm		Height 740 mm	
	REFERENCE	PM1G011612C		PM1G012212C	

STRUCTURE				
Straight legs	B	679,00	903,00	

SUPPORT				
Levelers	F			

FINISHES					
Surface	Edge	Structure	Ref.	↓	↓
White			M0000		
White	Lime Oak		M8111	+ 67,20	+ 67,20
	Lime Oak		M1111		
	Light Oak		M1010		
	Chestnut		M0707		
	Dark Oak		M1414		

OPTIONAL WIRED ACCESS				
	PC	+ 30,80	+ 30,80	
	QC	+ 75,60	+ 75,60	
	RC	+ 96,60	+ 96,60	

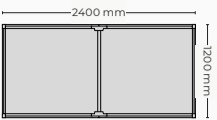
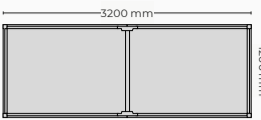
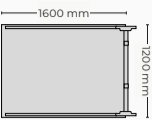

	<p>IMPORTANT NOTE: When ordering the table with the optional PC wiring access, please refer to the accessories section to order the power and data connection integrated in the table top. The optional PC wiring access only includes the cut-out in the table top.</p>
---	---

Meeting desk and middle Extension Width 1200 mm				
	MEASURES	2400 x 1200 mm	3200 x 1200 mm	1600 x 1200 mm - Progresión
	LEVELERS	Height 740 mm	Height 740 mm	Height 740 mm
	REFERENCE	PMIG012412C	PMIG013212C	PMIG021612C

STRUCTURE				
Straight legs	B	1.150,80	1.197,00	613,20

SUPPORT				
Levelers	F			

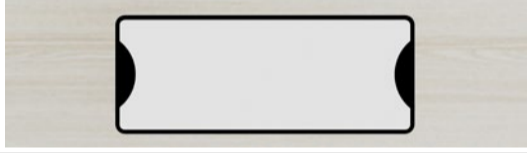
FINISHES						
Surface	Edge	Structure	Ref.	↓	↓	↓
White			M0000			
White	Lime Oak		M8111	+ 100,80	+ 100,80	+ 33,60
	Lime Oak		M1111			
	Light Oak		M1010			
	Chestnut		M0707			
	Dark Oak		M1414			

OPTIONAL WIRED ACCESS				
	PC	+ 61,60	+ 61,60	+ 30,80
	QC	+ 151,20	+ 151,20	+ 75,60
	RC	+ 193,20	+ 193,20	+ 96,60

	<p>IMPORTANT NOTE: When ordering the table with the optional PC wiring access, please refer to the accessories section to order the power and data connection integrated in the table top. The optional PC wiring access only includes the cut-out in the table top.</p>
--	--

Meeting desk Width 1400 mm				
	MEASURES	1400 x 1400 mm	2800 x 1400 mm	1400 x 1400 mm - Progresión
	LEVELERS	Height 740 mm	Height 740 mm	Height 740 mm
	REFERENCE	PMIG011414C	PMIG012814C	PMIG021414C

STRUCTURE				
Straight legs	B	684,60	1.365,00	618,80

SUPPORT				
Levelers	F			

FINISHES						
Surface	Edge	Structure	Ref.	↓	↓	↓
White			M0000			
White	Lime Oak		M8111	+ 67,20	+ 100,80	+ 33,60
	Lime Oak		M1111			
	Light Oak		M1010			
	Chestnut		M0707			
	Dark Oak		M1414			

OPTIONAL WIRED ACCESS				
	PC	+ 30,80	+ 61,60	+ 30,80
	QC	+ 75,60	+ 151,20	+ 75,60
	RC	+ 96,60	+ 193,20	+ 96,60

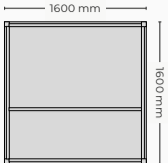
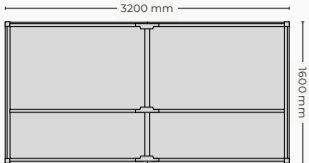
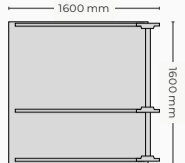

	<p>IMPORTANT NOTE: When ordering the table with the optional PC wiring access, please refer to the accessories section to order the power and data connection integrated in the table top. The optional PC wiring access only includes the cut-out in the table top.</p>
--	--

Meeting desk Width 1600 mm				
	MEASURES	1600 x 1600 mm	3200 x 1600 mm	1600 x 1600 mm - Progresión
	LEVELERS	Height 740 mm	Height 740 mm	Height 740 mm
	REFERENCE	PMIG011616C	PMIG013216C	PMIG021616C



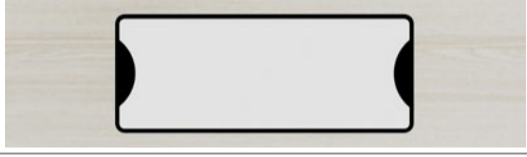

STRUCTURE				
Straight legs	B	911,40	1.722,00	767,20

SUPPORT				
Levelers	F			

FINISHES						
Surface	Edge	Structure	Ref.	↓	↓	↓
White			M0000			
White	Lime Oak		M8111	+ 67,20	+ 100,80	+ 33,60
	Lime Oak		M1111			
	Light Oak		M1010			
	Chestnut		M0707			
	Dark Oak		M1414			

OPTIONAL WIRED ACCESS				
	PC	+ 30,80	+ 61,60	+ 30,80
	QC	+ 75,60	+ 151,20	+ 75,60
	RC	+ 96,60	+ 193,20	+ 96,60

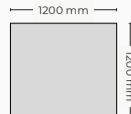
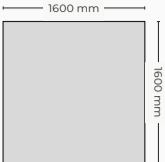
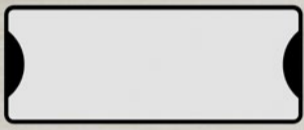
	<p>IMPORTANT NOTE:</p> <p>When ordering the table with the optional PC wiring access, please refer to the accessories section to order the power and data connection integrated in the table top. The optional PC wiring access only includes the cut-out in the table top.</p>
---	--

Meeting tables Height 1000 mm							
MEASURES		1600 x 800 mm	2000 x 1000 mm	1200 x 1200 mm	1600 x 1600 mm		
LEVELERS		Height 1000 mm	Height 1000 mm	Height 1000 mm	Height 1000 mm		
REFERENCE		PM1H011680C	PM1H012010C	PM1H011212C	PM1H011616C		
STRUCTURE							
Straight legs	B	624,40	750,40	690,20	978,60		
SUPPORT							
Levelers	F						
FINISHES							
Surface	Edge	Structure	Ref.	↓	↓	↓	↓
White			M0000				
White	Lime Oak		M8111	+ 113,40	+ 113,40	+ 113,40	+ 113,40
	Lime Oak		M1111				
	Light Oak		M1010				
	Chestnut		M0707				
	Dark Oak		M1414				
OPTIONAL WIRED ACCESS							
			QC	+ 75,60	+ 75,60	+ 75,60	+ 75,60
			RC	+ 96,60	+ 96,60	+ 96,60	+ 96,60

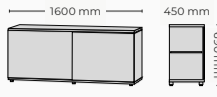
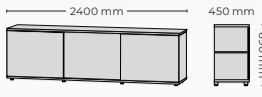
Auxiliary files Height 690 mm					
	MEASURES	1600 x 450 mm		2400 x 450 mm	
	LEVELERS	Height 690 mm		Height 690 mm	
	REFERENCE	PMM121645		PMM122445	

FINISHES				
Body	Doors	Ref.	↓	↓
White		M00M00		
Lime Oak	White	M11M00		
Lime Oak		M11M11		
Light Oak	White	M10M00		
Light Oak		M10M10	672,00	891,80
Chestnut	White	M07M00		
Chestnut		M07M07		
Dark Oak		M14M14		

Available complements

Modesty panel
Only for individual desks

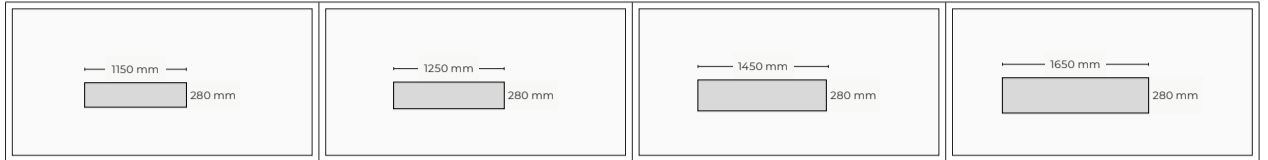

MEASURES	1150 x 280 mm	1250 x 280 mm	1450 x 280 mm	1650 x 280 mm
COMPATIBILITY	1400 mm desks	1600 and 2100 mm desks	1800 mm desks	2000 and 2200 mm desks
REFERENCE	XPMFA11128	XPMFA11228	XPMFA11428	XPMFA11628

BRACKETS FINISH

White	00	64,40	65,80	72,80	77,00
Black	08				

SURFACE FINISH

White	M00				
Lime Oak	M11				
Light Oak	M10				
Chestnut	M07				
Dark Oak	M14				

Pad manager
Desk Protector

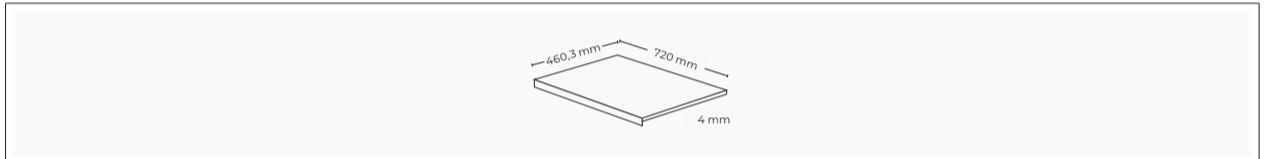

MEASURES	720 x 463 x 4 mm
REFERENCE	PAD5

INTEGRAL POLYURETHANE

Black	9	72,80
Red	7	

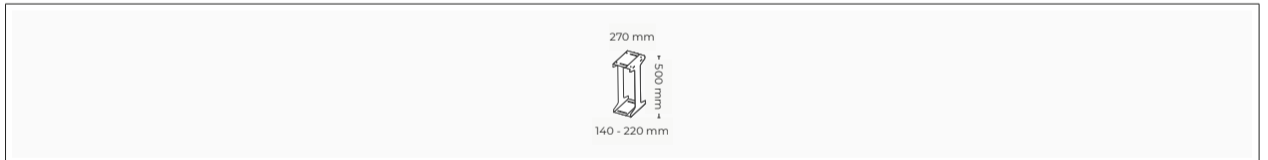

CPU support
Suspended and adjustable





MEASURES	500 x 270 x 140/220 mm
COMPATIBILITY	ATX CPUs from 140 to 220 mm wide
REFERENCE	50506

SHEET METAL FINISH

White	0	127,40
Black	8	

Cable risers Flexible polystyrene		
MEASURES	800 x 40,5 mm / Ø 40,5 mm	800 x 40,5 mm / Ø 70 mm
COMPATIBILTY	For use with P, Q and R access containers.	
MINIMUM UNITS ORDER	3 units · Price for 1 unit	
REFERENCE	39425	39525

FLEXIBLE POLYSTYRENE FINISH		
White	0	22,40
Black	8	26,60

Cable risers Sheet metal		
MEASURES	520 x 80 x 50 mm	625 x 150 x 100 mm
COMPATIBILITY	For use on single, quadruple and double progression desks.	
REFERENCE	5070	5071

FINISHING SHEET METAL		
White	0	112,00
Black	8	134,40

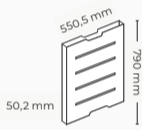
Cable risers Steel Sheet Totem	
MEASURES	550,5 x 790 x 50,2 mm
COMPATIBILITY	For wiring up to 1600 mm wide quadruple desks with recessed leg. Pack 1 unit.
REFERENCE	5073

FINISHING STEEL PLATE		
White	0	210,00
Black	8	

Cable risers Braided textile wrap		
PACKS	Pack 1 unit	Pack 4 units
MEASURES	750 mm / Ø 30 mm	
CHARACTERISTICS	Zippered for quick and easy installation. Offers additional protection against flame and abrasion.	
REFERENCE	39431	39434

FINISHING FABRIC		
Black	8	36,40
		131,60

Cable risers / Meeting tables height 1000 mm Flexible polystyrene	
MEASURES	1320 x 70 mm x 45 mm
COMPATIBILTY	For use with meeting tables height 1000 mm
MINIMUM UNITS ORDER	3 units · Price for 1 unit
REFERENCE	39526

FLEXIBLE POLYSTYRENE FINISH		
White	0	33,60
Black	8	

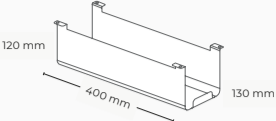
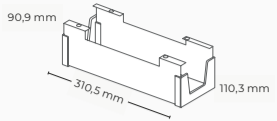
Accessories electrification systems Individual desks					
MEASURES		400 x 120 x 130 mm		310,5 x 90,9 x 110,3 mm	
COMPATIBILITY		Container for electrification accessories with P, Q and R wiring access.		Container for electrification accessories with T wiring access.	
PACKS		Pack 1 unit		Pack 2 units	
REFERENCE		CQR11		CQR12	

FINISHES					
White	0	68,60	133,00	53,20	102,20
Black	8				

Compatibility of cable container for individual and meeting desks

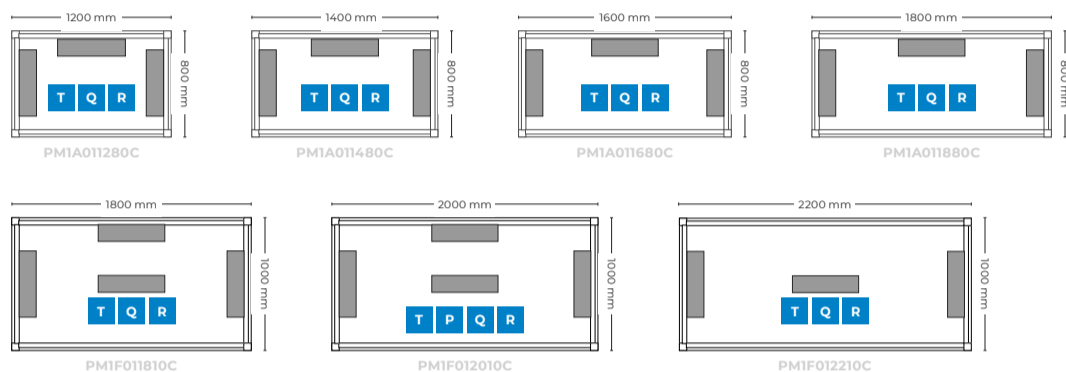

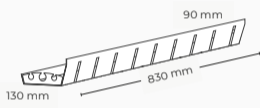
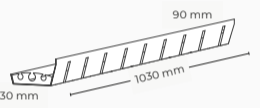
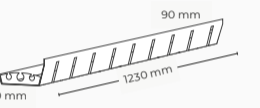
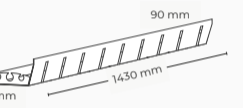
Simple Cable tray Individual desks									
MEASURES		830 x 80 x 140 mm		1030 x 80 x 140 mm		1230 x 80 x 140 mm		1430 x 80 x 140 mm	
COMPATIBILITY		1200 mm desks		1400 mm desks		1600 mm desks		1800, 2000 and 2200 mm desks	
PACKS		Pack 1 unit		Pack 1 unit		Pack 1 unit		Pack 1 unit	
REFERENCE		4018		4010		4012		4014	

STRUCTURE					
White	0	61,60	64,40	67,20	72,80
Black	8				

Compatibility of channels for individual and meeting desks

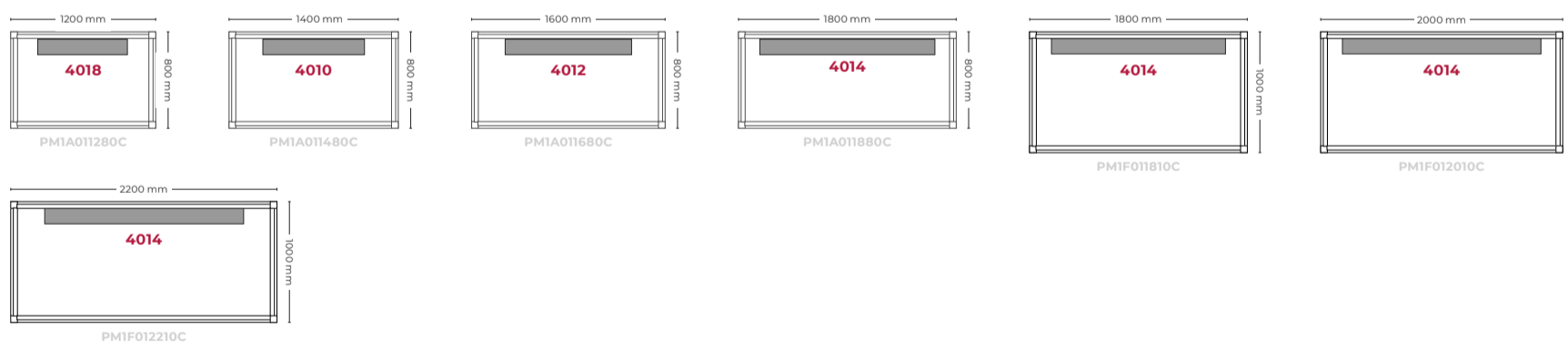

Power and data connection compatibility for meeting desks

Locate the requested table model to order the necessary power connection units for all meeting desks.



Example of power connection

Please refer to the following examples to order all the components required for the desired configuration. The **GX21** mains power cable must always be ordered. The power distributor **GX22** is included in the power connection with USB charging. In case of ordering a table with progressive desk and **power connection with HDMI**, the **GX22 connection spread kit** must be ordered for the progressive desk.

EXAMPLE 01

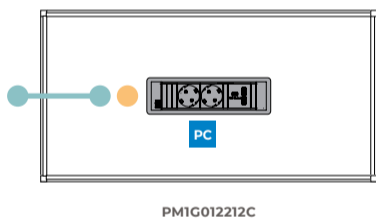

COMPONENTS	DESCRIPTION	UNITS
PM1G012212CBFM0000PC	Meeting table 220 x 120 cm with PC cable access	x1
XELBCP122081EU99	Power connection with 2 sockets + 2 USB charging sockets and without cover	x1
· GX21	2 metres extension cable, end power entry. EU · 220v	x1
· GX22	Connection spread kit	INCLUDED

EXAMPLE 02

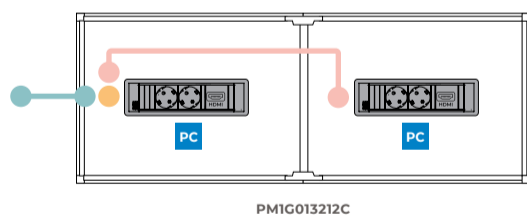

COMPONENTS	DESCRIPTION	UNITS
PM1G013212CBFM0000PC	Meeting table 320 x 160 cm with PC cable access	x1
XELBCP222081EU99	Power connection with 2 sockets + 1 HDMI and without cover	x2
· GX21	2 metres extension cable, end power entry. EU · 220v	x1
· GX22	Connection spread kit	x1
· GX20	Extension cable (1'5 m.)	x1

EXAMPLE 03

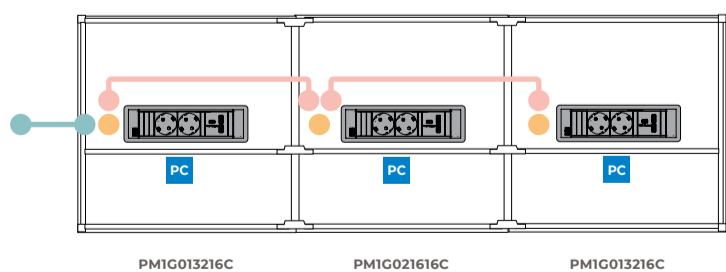



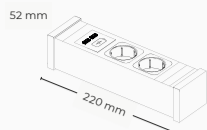
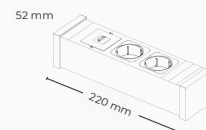
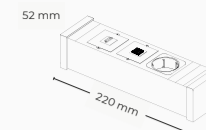

COMPONENTS	DESCRIPTION	UNITS
PM1G013216CBFM0000PC	Meeting table 320 x 160 cm with PC cable access	x1
PM1G021616CBFM0000PC	Extension table 160 x 160 cm with PC cable access	x1
XELBCP122081EU99	Power connection with 2 sockets + 2 USB charging sockets and without cover	x3
· GX21	2 metres extension cable, end power entry. EU · 220v	x1
· GX22	Connection spread kit	INCLUDED
· GX20	Extension cable (1'5 m.)	x2

Power and data connection Meeting desks			
COMPONENTS	2 plugs + 2 USB charging sockets GX22 INCLUDED (Connection spread kit)	2 plugs + 1 HDMI	1 plug + 1 HDMI + 2 USB charging sockets GX22 INCLUDED (Connection spread kit)
COMPATIBILITY	Integrated power and data connection for meeting desks with PC wiring access		
PACKS	Pack 1 unit	Pack 1 unit	Pack 1 unit
REFERENCE	XELBCP122	XELBCP222	XELBCP322

FRAME FINISH / INITIAL PRICE				
Black	08	315,00	240,80	380,80

CONNECTIVITY				
US · 120V	1US			
EU · 220V	1EU			
UK · 220V	1UK			

OPTIONAL TOP COVER				
Without cover	99			
White	00	+ 242,20	+ 242,20	+ 242,20
Black	08	+ 242,20	+ 242,20	+ 242,20

Electrical accessories Meeting desks					
COMPONENTS	Extension cable (1'5 m.)	End power entry 2 mts. EU · 220V	End power entry 2 mts. UK · 220V	End power entry 2 mts. US · 120V	Connection spread kit.
DESCRIPTION	Ø 10 mm. (3 x 2'5). Rubber hose Male and female connector to connect additional power module.	Ø 8 mm. (3 x 2). Rubber hose Plug and ground Ø 4'8 / 16A Female terminal plugged (with protection).			1 input / 3 outputs
MINIMUM UNITS ORDER	4 units · Price for 1 unit	4 units · Price for 1 unit	4 units · Price for 1 unit	4 units · Price for 1 unit	5 units · Price for 1 unit
REFERENCE	GX20	GX21	GX21L	GX21D	GX22
PRICE	37,80	40,60	40,60	40,60	26,60

Explanation of use of the cable tray - desks de reunión

Use of cable tray on Meeting desks of 120 cm:

To use electrification cable tray on desks of 120 cm width, request the desired/corresponding model, which is listed on the pricelist:

- 42cm width Cable tray: Usage on all Meeting desks - Length 50 cm.
- 29cm width Recessed Cable tray: Use on PM1G011612C meeting desk - Length 84 cm.
- 29cm width Recessed Cable tray: Use on PM1G012212C and PM1G013212C meeting desk - Length 104 cm.
- 29cm width Recessed Cable tray: Use on PM1G021612C meeting desk - Length 144 cm.

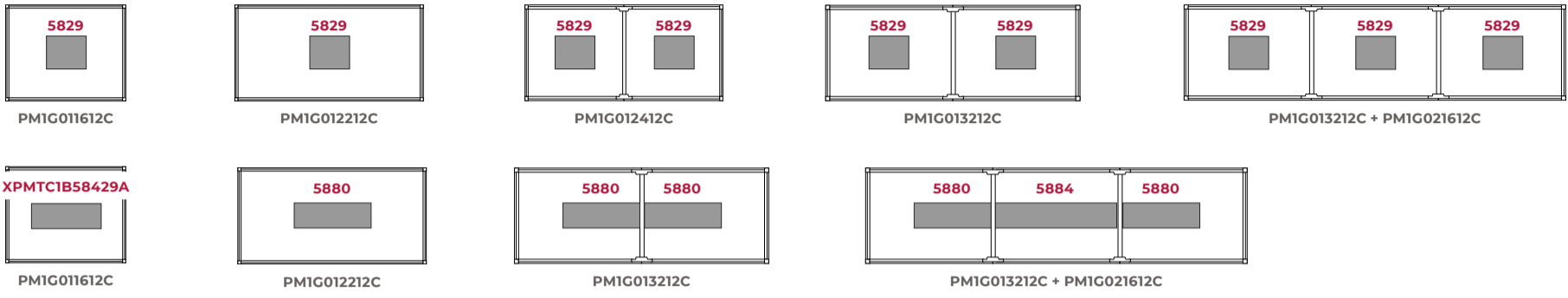

Use of cable tray on Meeting desks of 140 cm:

To use electrification cable tray on desks of 140 cm width, request the desired/corresponding model, which is listed on the pricelist::

- 42cm width Cable tray: Usage on all Meeting desks - Length 50 cm.
- 42cm width Recessed Cable tray: Use on PM1G012814C meeting desk - Length 104 cm.
- 42cm width Recessed Cable tray: Use on PM1G021414C meeting desk - Length 124 cm.

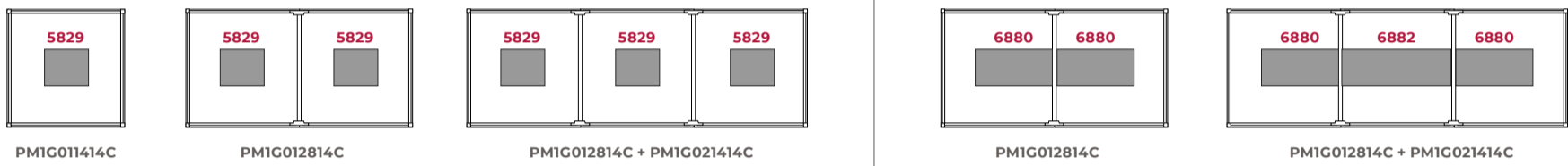

Use of cable tray on Meeting desks of 160 cm:

To use electrification cable tray on desks of 160 cm width, request the desired/corresponding model, which is listed on the pricelist:

- 42cm width Cable tray: Usage on all Meeting desks - Length 50 cm.
- 42cm width Recessed Cable tray: Use on PM1G013216C meeting desk - Length 104 cm.
- 42cm width Recessed Cable tray: Use on PM1G021616C meeting desk - Length 144 cm.

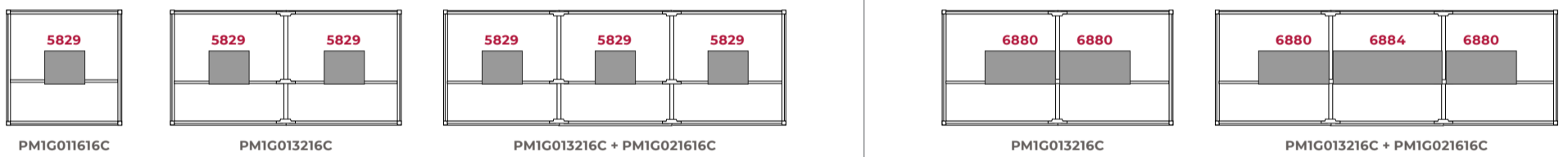

Cable tray fixed Width Meeting desks

MEASURES	500 x 420 x 38 mm	840 x 290 x 38 mm	1000,4 x 290 x 38 mm	1440 x 290 x 38 mm
COMPATIBILITY	With meeting desk	With desks PM1G011612C	With desks PM1G013212C and PM1G012212C	With desks PM1G021612C
REFERENCE	5829	XPMTTC1B58429A	5880	5884

STRUCTURE					
White	0	70,00	91,00	99,40	119,00
Black	8				

Fixed height cable tray Meeting desks

MEASURES	1040 x 420 x 38 mm	1240 x 420 x 38 mm	1440 x 420 x 38 mm
COMPATIBILITY	Central desks of the 1200mm progressions. - Desks for individual use of 1400 and 1600 mm. - 1400 and 1600 mm. quadruple desks or progression end desks.	Central desks of the 1400mm progressions.	Central desks of the 1600mm progressions.
REFERENCE	6880	6882	6884

STRUCTURE				
White	0	105,00	112,00	120,40
Black	8			

EXPLANATION OF USE OF THE CABLE TRAY - DOUBLE OPERATIVE DESKS AND EXTENDABLE DOUBLE DESKS

Use of cable tray on double operative desks and extendable double desks:

To use electrification cable tray on double and middle extension desks, ask for the corresponding/desired model, which is listed on the pricelist.

- 42cm width Cable tray - Length 50 cm: Usage on all Operative double desks - Length 50 cm.
- 42cm width Recessed Cable tray: Usage on all Operative double desks - Length 84 / 104 / 124 / 144 cm.

Fixed-height Cable tray compatibility for doubles, quads and progression desks

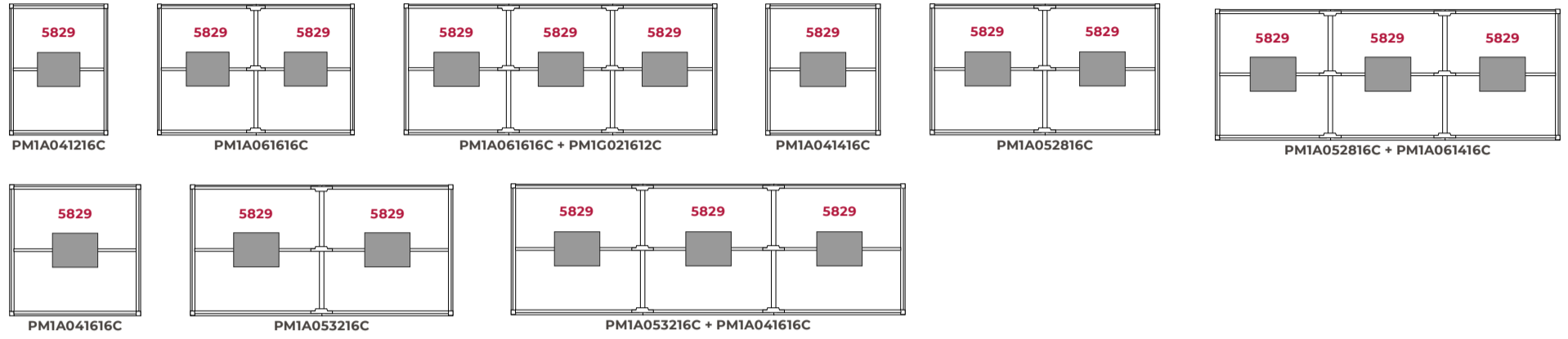

Fixed-height recessed Cable tray compatibility for doubles, quads and progression desks

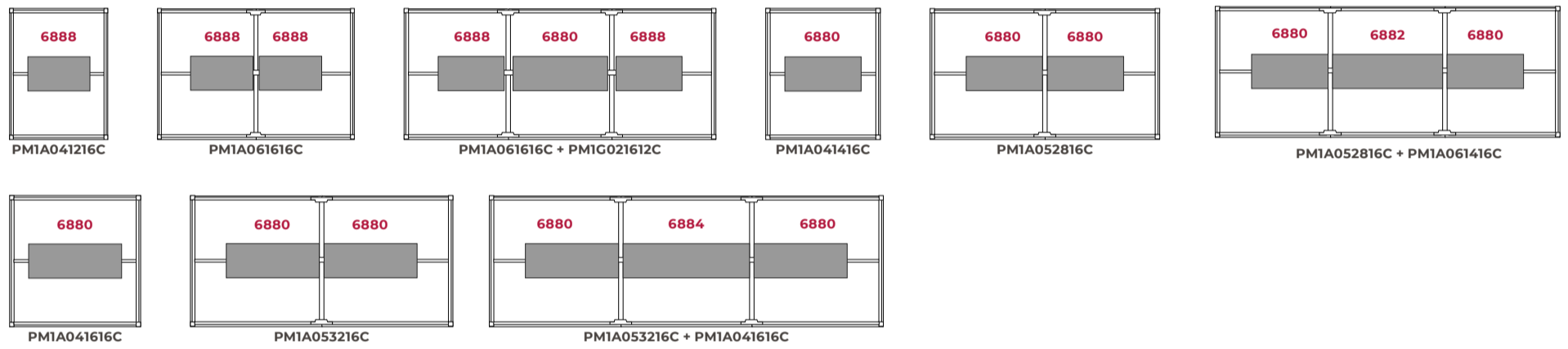

Height-adjustable recessed Cable tray compatibility for doubles, quads and progression desks

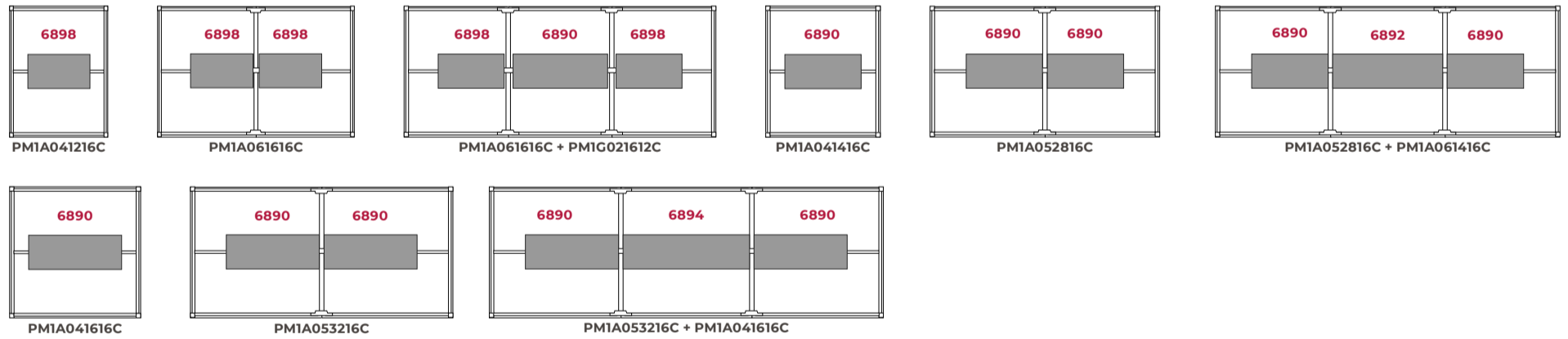

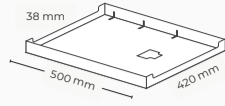

Fixed Width Cable tray Double, quadruple and progression desks		
MEASURES	500 x 420 x 38 mm	
COMPATIBILITY	For use on all models of double, quadruple and progression desks.	
REFERENCE	5829	

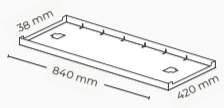
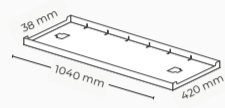
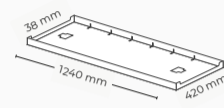
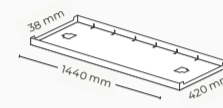
STRUCTURE		
White	0	70,00
Black	8	

Fixed height Cable tray Double, quadruple and progression desks					
MEASURES	840 x 420 x 38 mm	1040 x 420 x 38 mm	1240 x 420 x 38 mm	1440 x 420 x 38 mm	
COMPATIBILITY	Individual desks of 1200 mm. - Quadruple or end desks of progression of 1200 mm.	Central desks of the 1200mm progressions. - Desks for individual use of 1400 and 1600 mm. - 1400 and 1600 mm. quadruple desks or progression end desks.	Central desks of the 1400mm progressions.	Central desks of the 1600mm progressions.	
REFERENCE	6888	6880	6882	6884	

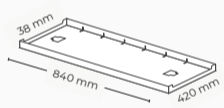
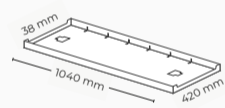
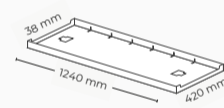
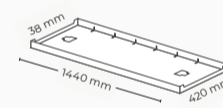
STRUCTURE					
White	0	103,60	105,00	112,00	120,40
Black	8				

Height-adjustable Cable tray Double, quadruple and progression desks					
MEASURES	840 x 420 x 38 mm	1040 x 420 x 38 mm	1240 x 420 x 38 mm	1440 x 420 x 38 mm	
POSITIONS					
COMPATIBILITY	Individual desks of 1200 mm. - Quadruple or end desks of progression of 1200 mm.	Central desks of the 1200mm progressions. - Desks for individual use of 1400 and 1600 mm. - 1400 and 1600 mm. quadruple desks or progression end desks.	Central desks of the 1400mm progressions.	Central desks of the 1600mm progressions.	
REFERENCE	6898	6890	6892	6894	

STRUCTURE					
White	0	138,60	145,60	159,60	162,40
Black	8				

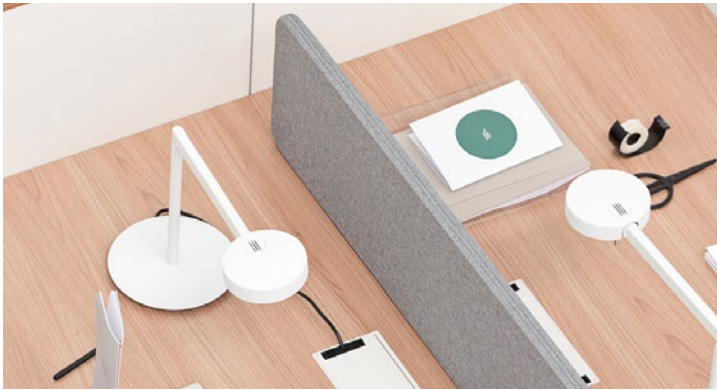

■ **Desks mounted screens**

Desk-Mounted screens, different sizes available, fixing kits and finishes. Easy to be adapted to any surface. They provide visual contact but at the same time privacy. Twin desks with electrification system have their own desk-mounted screens (**ID50 Serie for Vital or Arkitek**)

■ **DESK MOUNTED SCREENS OFFER**

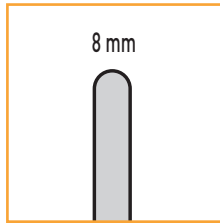

GLASS SCREEN - e=8mm

Laminated Security Glass (4+4 mm) / Tempered glass (8 mm)

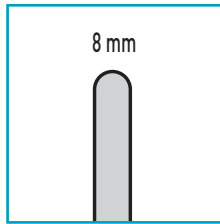

METHACRYLATE SCREEN - e=8mm

8 mm thick White Methacrylate

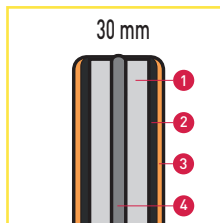

UPHOLSTERED SCREEN WITH FLEXIBLE PROFILE - e=30mm

- ① 19 mm thick Chipboard
- ② Foam thickness e= 5 mm and 60 Kg/m³ density (etotal= 30 mm)
- ③ Different fabrics available glued using water glue.
- Optional acoustic or fire resistant fabrics for projects.
- ④ 8mm thick flexible Profile

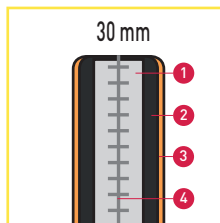
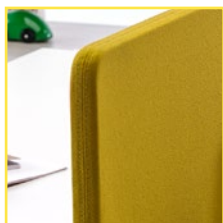

UPHOLSTERED SCREEN. SEWAN AND SEATHED - e=30mm

- ① 19 mm thick Chipboard
- ② Foam thickness e= 5 mm and 60 Kg/m³ density (etotal= 30 mm)
- ③ Different fabrics available glued using water glue.
- Optional acoustic or fire resistant fabrics for projects.
- ④ Sewn and sheathed.

EXAMPLE OF AN ORDER

Model	Bracket finish	Divider Finish	Final Reference
DLN432 Screen mobile Pack 2 units	N Black bracket	T82 Group T Upholstered	DLN432NT82

TABLE TOP DIVIDERS FOR: USE ON DOUBLE DESKS ET INDIVIDUAL DESKS AND CROSS USE ON DOUBLE PROGRESSIVE DESKS

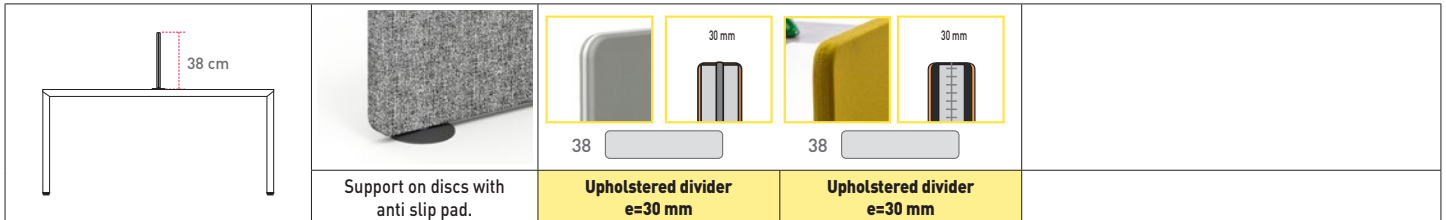

Model Dimensions (A x B)	ZW43 110 38	ZW44 130 38	ZW45 150 38
	TABLE TOP DIVIDER FOR 120, 140 and 160 cm DESK	TABLE TOP DIVIDER FOR 140 and 160 cm DESK	TABLE TOP DIVIDER FOR 160 cm DESK

Coding required to configure reference.
They do not mean an increase in cost

Units / Pack		Pack 1 Unit	Pack 2 Units	Pack 1 Unit	Pack 2 Units	Pack 1 Unit	Pack 2 Units
Base Reference		ZW431	ZW432	ZW441	ZW442	ZW451	ZW452
Bracket finish	WHITE	0					
	BLACK	8					

FLEXIBLE PROFILE UPHOLSTERED DIVIDER e= 30 mm - h= 38 cm

Upholstered e=30 Flexible profile	GROUP 0	Group T	3T--	180,60	344,40	186,20	358,40	198,80	386,40
	GROUP 1	Group AE	3AE--	207,20	397,60	218,40	422,80	259,00	506,80
Group AO		3AO--							
GROUP 2	Group D	3D--	217,00	425,60	232,40	450,80	287,00	558,60	
	Group M	3M--							

Model Dimensions (A x B)	DLN43 110 38	DLN44 130 38	DLN45 150 38
	TABLE TOP DIVIDER FOR 140 and 160 cm DESK	TABLE TOP DIVIDER FOR 140 and 160 cm DESK	TABLE TOP DIVIDER FOR 160 cm DESK

Units / Pack		Pack 1 Unit	Pack 2 Units	Pack 1 Unit	Pack 2 Units	Pack 1 Unit	Pack 2 Units
Base Reference		DLN431	DLN432	DLN441	DLN442	DLN451	DLN452
Bracket finish	WHITE	B					
	BLACK	N					

SEWN AND SHEATHED UPHOLSTERED DIVIDER e= 30 mm - h= 38 cm

Upholstered e=30 Sewn and sheathed	GROUP 0	Group T	T--	212,80	414,40	218,40	428,40	235,20	456,40
	GROUP 1	Group AE	AE--	239,40	467,60	253,40	498,40	294,00	574,00
Group AO		AO--							
GROUP 2	Group D	D--	252,00	494,20	267,40	522,20	320,60	628,60	
	Group M	M--							
GROUP 3	Group A	A--	298,20	585,20	319,20	625,80	380,80	749,00	

EXAMPLE OF AN ORDER

Model	Bracket finish	Divider Finish	Final Reference
DPM432 Screen for frontal use Pack 2 units	N Black bracket	T82 Group T Upholstered	DPM432NT82

TABLE TOP DIVIDERS FOR - FRONTAL USE ON INDIVIDUAL AND DOUBLE DESKS

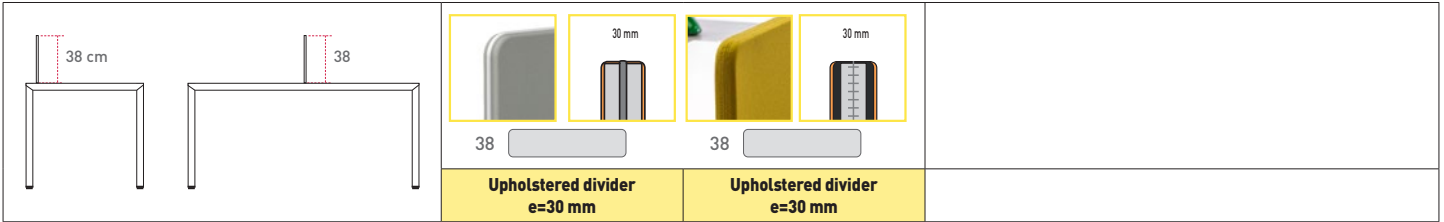

Model Dimensions (A x B)	ZL43 110 38	ZL44 130 38	ZL45 150 38
	TABLE TOP DIVIDER FOR 120 and 160 cm DESK	TABLE TOP DIVIDER FOR 140 and 160 cm DESK	TABLE TOP DIVIDER FOR 160 cm DESK

Coding required to configure reference.
They do not mean an increase in cost

Units / Pack		Pack 1 Unit	Pack 2 Units	Pack 1 Unit	Pack 2 Units	Pack 1 Unit	Pack 2 Units
Base Reference		ZL431	ZL432	ZL441	ZL442	ZL451	ZL452
Bracket finish	WHITE	0					

FLEXIBLE PROFILE UPHOLSTERED DIVIDER e= 30 mm - h= 38 cm

Upholstered 11/2" Flexible profile	GROUP 0	Group T	3T--	154,00	294,00	159,60	306,60	172,20	333,20
				GROUP 1	Group AE	3AE--	180,60	347,20	191,80
Group AO	3AO--								
GROUP 2	Group D	3D--	193,20	373,80	205,80	400,40	261,80	508,20	
	Group M	3M--							

Model Dimensions (A x B)	DPM43 110 38	DPM44 130 38	DPM45 150 38
	TABLE TOP DIVIDER FOR 120 and 160 cm DESK	TABLE TOP DIVIDER FOR 140 and 160 cm DESK	TABLE TOP DIVIDER FOR 160 cm DESK

Units / Pack		Pack 1 Unit	Pack 2 Units	Pack 1 Unit	Pack 2 Units	Pack 1 Unit	Pack 2 Units
Base Reference		DPM431	DPM432	DPM441	DPM442	DPM451	DPM452
Bracket finish	WHITE	B					

SEWN AND SHEATHED UPHOLSTERED DIVIDER e= 30 mm - h= 38 cm

Upholstered 11/2" Sewn and sheathed	GROUP 0	Group T	T--	187,60	362,60	194,60	378,00	208,60	403,20
				GROUP 1	Group AE	AE--	214,20	415,80	229,60
Group AO	AO--								
GROUP 2	Group D	D--	225,40	441,00	242,20	470,40	295,40	575,40	
	Group M	M--							
GROUP 3	Group A	A--	273,00	533,40	294,00	572,60	354,20	694,40	

EXAMPLE OF AN ORDER

Model	Divider Finish	Bracket finish	Final Reference
DPM432 Screen for frontal use Pack 2 units	90 White Methacrylate	B White bracket	DPM43290B

TABLE TOP DIVIDERS FOR - FRONTAL USE ON INDIVIDUAL AND DOUBLE DESKS

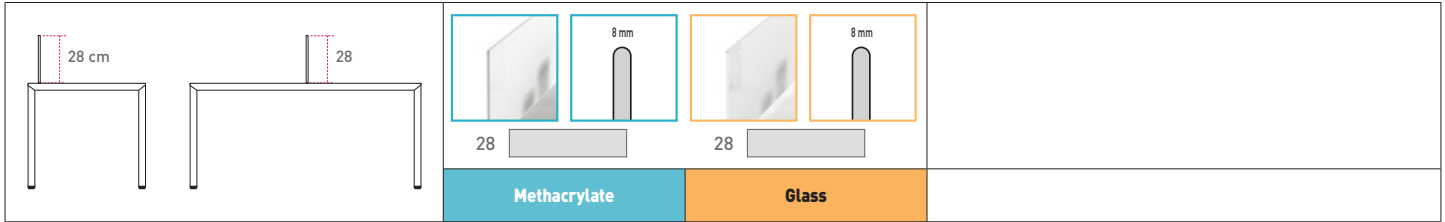

	Model Dimensions (A x B)	DPM43		DPM44		DPM45		
		110	130	150				
		28	28	28	28	28	28	
		TABLE TOP DIVIDER FOR 140, 160 and 180 cm DESK		TABLE TOP DIVIDER FOR 140, 160 and 180 cm DESK		TABLE TOP DIVIDER FOR 160 and 180 cm DESK		
Units / Pack		Pack 1 Unit	Pack 2 Units	Pack 1 Unit	Pack 2 Units	Pack 1 Unit	Pack 2 Units	
Base Reference		DPM431	DPM432	DPM441	DPM442	DPM451	DPM452	
METHACRYLATE DIVIDER e = 8 mm - h = 28 cm								
Methacrylate	White	90	141,40	271,60	155,40	295,40	165,20	319,20
GLASS DIVIDER e = 8 mm - h = 28 cm								
Glass	White	52	246,40	481,60	274,40	533,40	301,00	588,00
Bracket finish	WHITE	B						
	BLACK	N						

Coding required to configure reference.
They do not mean an increase in cost