

Malmö

Design Michele Cazzoniga, Simone Mandelli, Antonio Pagliarulo



Malmö



Art. 390 - 395

La struttura in massello di frassino di sedia e poltrona Malmö sostiene una scocca in multistrato curvato, sollevandolo ed esaltandone i particolari costruttivi. La sedia impilabile e la poltrona sono state pensate come oggetti accoglienti caratterizzati da linee morbide. Finiture in essenza di frassino sbiancato, tinto nero o tinto grigio chiaro.

Malmö chair and armchair ash timber frame supports a multilayer curved shell, with the aim to raise it enhancing its design particulars. The stackable chair and the armchair had been devised as comfortable items characterised by soft lines. Bleached ash, black or light grey stained finish.

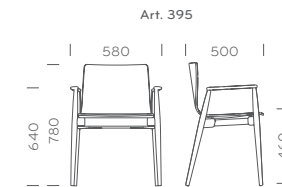
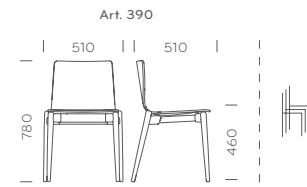

Finiture: / Finishes:



FR

AN

GC



390



390



395

Malmö

Art. 391 - 396
Massimo comfort per le versioni sedia e poltrona Malmö con scocca imbottita, rivestita in tessuto, vera o finta pelle.
Great comfort for Malmö chair and armchair upholstered version, fabric, mid grain or simil leather covering.

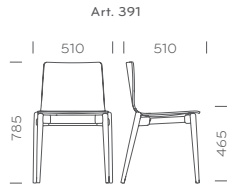
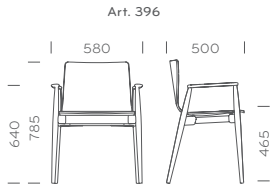

Finiture / Finishes:

		
FR	AN	GC



396



391



Malmö

Art. 392 - 397
Sedia e poltrona Malmö sono disponibili anche con scocca rivestita in cuoio naturale o rigenerato con cuciture in tinta.
Malmö chair and armchair, genuine or regenerated leather shell with matching stitches.

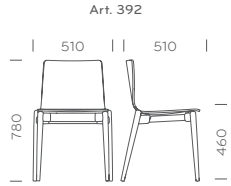
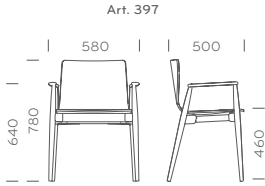

397



Malmö

Art. TML_190X90

Il tavolo allungabile Malmö ha gambe in frassino, disponibile nelle finiture sbiancato o tinto nero, abbinato a ripiano in stratificato o impiallacciato. Disponibile anche nella versione fissa in 3 dimensioni: 900x900mm (Art. TMLF_90X90), 1400x900mm (Art. TMLF_140X90), 1800x900mm (Art. TMLF_180X90).

Malmö extendable table has ash wooden legs in bleached or black stained finish matched with solid laminate or osh veneered table top. Fixed versions in three dimensions also available: 900x900mm (Art. TMLF_90X90), 1400x900mm (Art. TMLF_140X90), 1800x900mm (Art. TMLF_180X90).

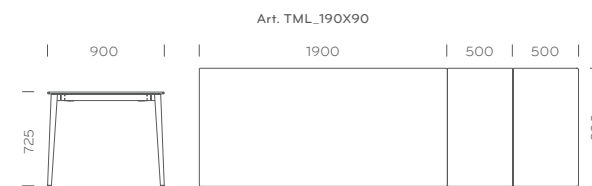

Malmö



Malmö

Art. 295 - 296 - 297

Poltrona Lounge con struttura in essenza di frassino, scocca in multistrato impiallacciato frassino, imbottito oppure rivestito in cuoio.
Lounge chair in solid ash wood, plywood shell ash veneered, upholstered or leather seat version.

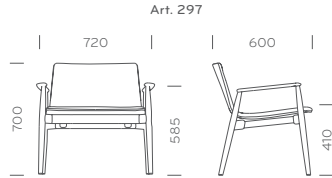
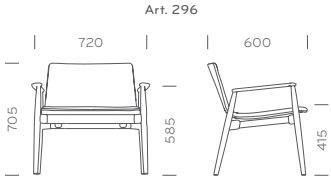
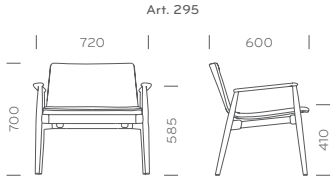

Finiture: / Finishes:

		
FR	AN	GC



296



295



Malmö

Art. 232 - 242 - 252 - 236 - 246 - 256

Sgabelli con struttura in essenza di frassino, scocca in multistrato impiallacciato frassino, imbottito oppure rivestito in cuoio. Disponibili nelle altezze 650mm e 750mm.
Barstools in solid ash wood, plywood shell ash veneered, upholstered or leather seat version.
Two heights available: 650mm and 750mm.

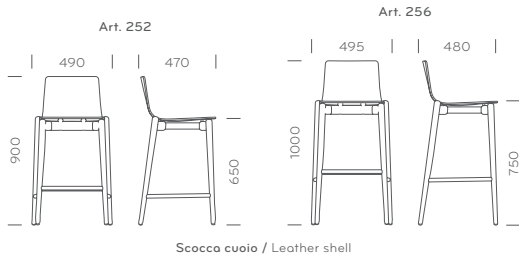
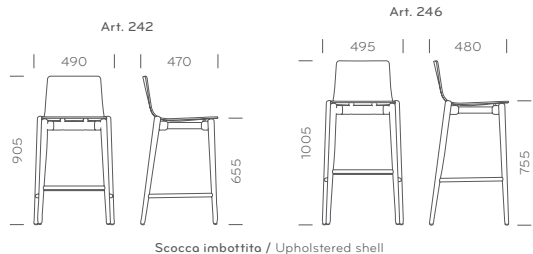
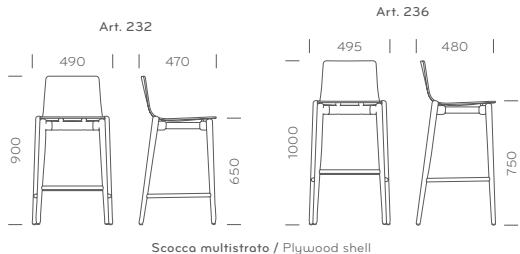

Finiture: / Finishes:

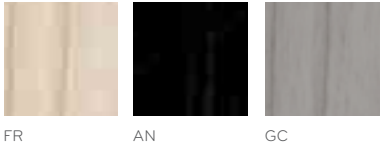

232



232



246

Malmö

Art. MLT

Coffee tables con ripiano in mdf laccato, impiallacciato frassino o stratificato. Gambe in massello di frassino tornite.
 Coffee tables with lacquered mdf top, ash veneered top or solid laminate tops. Tapered legs in ash wood.

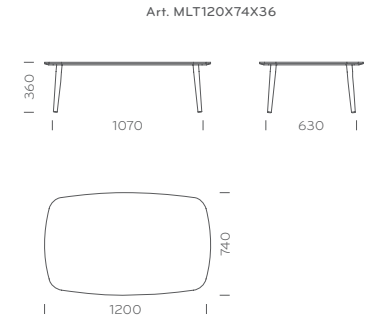
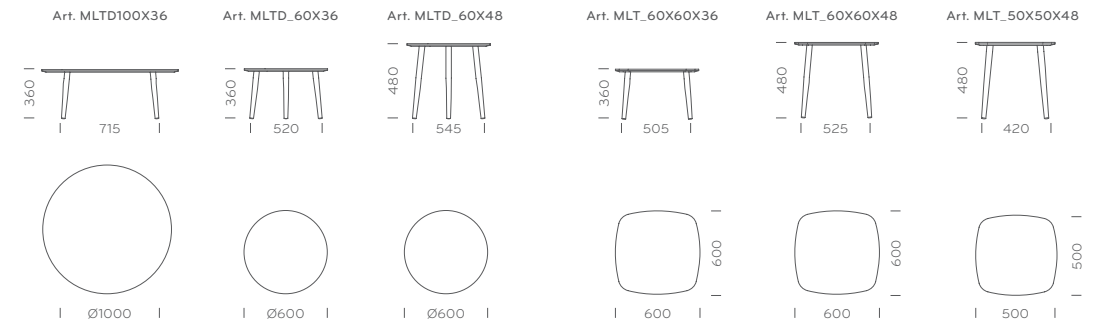

MLT120X74X36